

**MONITORING AND ASSESSMENT
OF CORAL REEFS IN SPERMONDE ARCHIPELAGO,
SOUTH SULAWESI, INDONESIA.**

BY

JAMALUDDIN JOMPA

**MONITORING AND ASSESSMENT
OF CORAL REEFS IN SPERMONDE ARCHIPELAGO,
SOUTH SULAWESI, INDONESIA.**

BY

**JAMALUDDIN JOMPA
B.Sc., SARJANA**

**A thesis
Submitted to the School of Graduate Studies
in Partial Fulfillment of the Requirements
for the Degree
Master of Science**

McMaster University

April 1996

**MASTER OF SCIENCE
(BIOLOGY)**

McMASTER UNIVERSITY

**TITLE : Monitoring and Assessment of Coral Reef in Spermonde Archipelago,
South Sulawesi, Indonesia.**

AUTHOR : Jamaluddin Jompa, B.Sc.

(Universitas Hasanuddin)

SUPERVISORS : Dr. Michael J. Risk

Dr. Jurek Kolasa

NUMBER OF PAGES : x, 81

ABSTRACT

Four coral reef sites were observed in Spermonde Archipelago, off South-west Sulawesi, Indonesia. The sites were located at different distances from the mainland: Kayangan reef ('affected' site) is the closest and Samalona, Barang Lompo, and Kapoposan ('comparison' sites) are successively farther from the mainland and Ujung Pandang city.

Coral cover, number of species at 3m and 10m depths, and coral growth rates (*Porites lobata*) were observed to describe coral conditions. Environmental parameters suspended particulate matter (SPM), resuspended sediment, salinity, clarity, chlorophyll a, phosphate, nitrate, ammonium and $\delta^{15}\text{N}$ values of coral tissue (*P. lobata*) were also investigated to assess possible 'stress' factors on the reefs.

Average coral cover at the 'affected' site was very low (14 %), compared to the other sites: Samalona (44.3 %), B. Lompo (47.2 %) and Kapoposan (66.6 %). Also, the lowest total number of species occurred at Kayangan (42 spp.), compared to the other sites: Samalona (62 spp.), B. Lompo (71 spp.) and Kapoposan (80 spp.)

Environmental parameters indicated that sedimentation and eutrophication (sewage) were the main 'stress' factors at Kayangan reef, while human disturbances such as fish bombing, anchoring, coral collection, and other activities affected Samalona and B. Lompo more. High coral cover and number of species at Kapoposan reef indicated fewer 'stress' factors.

Coral growth rates showed a different trend from coral cover and total number of species. The highest coral growth rates occurred at B. Lompo (15.9 ± 0.8 mm yr⁻¹) followed by Kayangan, Samalona and Kapoposan. Based on environmental parameters, it seemed that coral growth rates were higher at more eutrophic reefs, but slower at certain maximum critical nutrient values.

$\delta^{15}\text{N}$ values of coral tissue found in this study are positively correlated with chlorophyll a, dissolved nutrients, and sedimentation rates. The high $\delta^{15}\text{N}$ values at Kayangan (8.03 ± 0.62 ‰) support the idea that this site was affected by human waste and sewage.

ACKNOWLEDGMENTS

First of all, I would like to thank my supervisor Dr. M.J. Risk for giving me opportunity to do research in Indonesia, providing me financial support for this research project, and for his encouragement and his patience in editing this thesis. Thanks also go to my supervisory committee Dr. J. Kolasa for his great help in statistic and editing and to Dr. J. Quinn for his constructive criticisms.

Many other people contributing to this work in various ways, without them, this thesis would have been impossible. I would like to thank;

- Proff. Dr.H.M. Natsir Nessa, MS, Ir. Arsyuddin Salam, M.Agr. F., Ir. I Nengah Sutika, MSc, Ir. Aspari Rachman, William Moka and other staff of Marine Science and Fisheries, Hasanuddin University for providing me great support and facilities.
- My excellent diving buddy Muchsin, who help me a lot during field works and in organizing this research which was not easy.
- Evan Edinger, who helped me in field works, especially for coral identifications and for scientific discussion.
- Sudirman, Syahriadi, Toni, Ridwan and his wife, Mansyur, Takdir, Sahar, Ifan, Iful, Syafruddin, Sri, Ida, Setiorini, Rijo, Badamang, Saleh and his wife, and all my friends for their great supports.
- Gino Limmon, Rita Takarina, Jodie Smith, David Brown, Jennifer, Jeff, Ines Romero, Martin, Abd. Kabir, Edna, and many other students and Geology and Biology staff for their great companies and supports during my study in McMaster University.
- For my lovely parent, sisters and brothers, your support and help have been invaluable.
- Many other people who helped me that I do not mention here.

Again, thanks a lot for all of you.

TABLE OF CONTENTS

	Page
Abstract	iii
Acknowledgments	v
Table of Contents	vi
List of Tables	ix
List of Figures	x
I. Introduction	1
1.1. Basic Biological and Ecological Features of Coral Reefs	1
1.2. The Important Role of the Reef	2
1.3. The Spermonde Archipelago	4
1.3.1. General Description	4
1.3.2. Meteorological Conditions	4
1.3.3. Oceanographic Conditions	6
1.3.4. Previous Work	8
1.3.5. Social and Economic Activities	9
1.4. Study Scope and Objective	10
II. Methodology	12
2.1. Line Intercept Transect	12
2.2. Coral Growth Rates	13
2.3. Water Quality and Nutrients	13
2.4. Suspended Particulate Matter (SPM)	15
2.5. Resuspended Sediment	16
2.6. Coral Diversity	18
2.7. Nitrogen Isotope Ratios ($\delta^{15}\text{N}$)	19
2.8. Data Analyses	20

2.9. Study Sites	21
------------------------	----

III. Results

3.1. Coral Cover	22
3.2. Growth Rates	24
3.3. Coral Diversity	26
3.4. Sediment	28
3.4.1. Suspended Particulate Matter (SPM)	28
3.4.2. Resuspended Sediment	30
3.5. Sea Water Quality and Dissolved Nutrients	33
3.5.1. Chlorophyll α	33
3.5.2. Sea Water Clarity	34
3.5.3. Salinity	35
3.5.4. Dissolved Nutrient	36
3.6. Nitrogen Isotope Ratios ($\delta^{15}\text{N}$)	38

IV. Discussions

4.1. Coral Reef Conditions and Environmental Factors	40
4.2. Coral Cover and Number of Species	43
4.3. Growth Rates	46
4.4. Nitrogen Isotope Ratios ($\delta^{15}\text{N}$)	49

V. Conclusions and Recommendations

5.1. Conclusions	50
5.2. Recommendations	51

References	52
------------------	----

Appendix A. Surface current on Indonesia sea	60
--	----

Appendix B. The average values of temperature (°C) in U. Pandang	61
Appendix C. The average value of monthly total rainfall (mm) in U. Pandang ..	62
Appendix D. The average monthly values of wind velocities (km/h) in Ujung Pandang	63
Appendix E. Lifeform categories and codes	64
Appendix F. Examples of lifeform categories	66
Appendix G. Pie charts of benthic communities at all sites	69
Appendix H. The averages of coral growth rates at all stations	73
Appendix I. Lists of coral species found in this study at all sites	75
Appendix J. Simple linear regression analyses of gradient of phosphate concentration at four sites	79
Appendix K. Simple linear regression analyses of gradient of $\delta^{15}\text{N}$ values at four sites	80
Appendix L. 1. Spearman correlation coefficient (r) between coral conditions and environmental parameters 2. Summary of coral conditions and environmental parameters	81

LIST OF TABLES

Table 2.1	The sampling description and number of sampling at all study sites	14
Table 2.2	General description and assumed stresses in study sites	21
Table 3.1	Summary of benthic lifeform at 3m depths and total hard coral cover	22
Table 3.2	Summary of benthic lifeform at 10m depths and total hard coral cover	23
Table 3.3	Means of coral growth rates, standard deviations and sample sizes	26
Table 3.4	Total number of coral species and species shared between depths and among sites	27
Table 3.5	The value of SPM concentration at all stations and condition of sea water surface during sampling	29
Table 3.6	The average values of resuspended sediment at each different height from the bottom	33
Table 3.7	The values of chlorophyll α concentration on sea water column	34
Table 3.8	The values of water clarity at all station	35
Table 3.9	The value of salinity (‰) from May to August	36
Table 3.10	The value of dissolved nutrient concentration (PO ₄ -P, NO ₃ -N, and NH ₄ -N)	37
Table 3.11	$\delta^{15}\text{N}$ values of coral samples (<i>P. Lobata</i>) at all sites	39

LIST OF FIGURES

Figure 1.1 Map of Spermonde Archipelago which shows the reef locations o f the study area	5
Figure 1.2 Surface current around Sulawesi Island	7
Figure 1.3 The approximate geographical location of surface water types in the south Makassar Strait	7
Figure 2.1 Sediment trap construction	17
Figure 3.1 Coral (<i>Porites lobata</i>) growth-rates	25
Figure 3.2 Number of coral species along the transect line	27
Figure 3.3 The average value of SPM concentration on June and July 1995 around river mouths outward	31
Figure 3.4 Resuspended sediment graphs at different depths from the bottom	32

CHAPTER I

INTRODUCTION

1.1. Basic Biological and Ecological Features of Coral Reefs

The existence of modern coral reefs is the outcome of a most complex and intricate relationship between the coral polyp and the tiny single-celled algae (zooxanthellae) which live symbiotically within the cell of the polyp (Veron, 1986). The symbiotic relationship between them is the most significant factor which defines the particular environmental requirements of reef-building corals. Zooxanthellae are provided with living space in a well-protected habitat (inside the coral tissue) and are supplied with nutrients (from the excretion of the coral) and carbon dioxide. The corals benefit from the symbiosis by using the photosynthetically fixed carbon as a major food source for calcification and to increase growth by the efficient removal of the waste products (Goreau, 1961; Constantz, 1986; Tomascik, 1993; and Carter, 1994). These corals are grouped as hermatypic (reef-building) corals to differentiate with ahermatypic (non reef-building) corals which usually do not require zooxanthellae-symbiont.

Hermatypic corals usually develop best with high water clarity, low nutrient availability and a mean annual temperature range between 23-28 °C, but they can be found in temperatures of between 16 and 34 °C (Glynn and Stewart, 1973; Smith, 1976; Tomascik, 1993;). Salinity tolerance limits for hermatypic corals are between

25 and 40 ‰ (Yonge, 1968, 1973; Newel, 1972). The deepest that hermatypic coral can grow is about 50 m (Veron, 1986), but the most vigorous coral reef development occurs between 2 and 15 meters water depth (Tomascik, 1993).

Coral growth process is very complex. Lowenstan (1981) believed that mineral growth in corals proceeds in either of two different ways; one way involves crystal growth on an organic matrix and the other is biologically induced. Constantz (1986) stated that coral skeleton construction is a physiochemically dominated process, while Davies (1983) believed that reef growth involves the increase of both organic material and calcium carbonate. Discussion about coral growth can also be found in Goreau (1959; 1961), Buddemeier and Kinzie (1976), Highsmith (1979), Risk *et al.*, (1987), and Barnes and Lough (1993).

1.2. The Important Role of the Reef

Coral reefs have been known to have very important roles both for people, especially those who live along coasts, and for nature itself. They are the foundation and support of maintenance of thousands of islands; they protect the coastal margin of larger islands and continents from oceanic waves (Craik *et al.*, 1990). Coral reefs also have rich fisheries resources (Risk, 1972, Munro and Williams, 1985, and Craik *et al.*, 1990).

Coral reefs also are considered to be net sinks for carbon, mainly in the form of calcium carbonate. It has been suggested (Carter, 1984) that coral reefs worldwide act

as a sink for about 2 % of the present output of anthropogenic carbon dioxide. They also have links with adjacent mangrove and seagrass communities. Coral reefs contribute an important role as self-repairing breakwater, which contributes to the low energy condition essential for seagrass and mangrove development (Carter, 1984; Hatcher *et.al.*, 1989).

Further, Tomascik (1993) mentioned other important roles of coral reefs for society which are summarized as follows; use of reef areas for land reclamation and siting of structures in the coastal zone; collection of reef organisms for making jewelry and for the curio trade; the aquarium trade, involving the large scale collection of reef fish and invertebrates; marine tourism, such as snorkeling and SCUBA diving in targeted coral reef areas; mariculture; opportunities for education and research; potential for preparation of natural products for medical and pharmaceutical purposes.

Therefore, coral reefs have many important natural and commercial functions. However, because the usage of the reef is increasing and changing, and there is increasing pressure from pollution and eutrication, coral reef degradation is widespread and increasing in most parts of the world (Cortes, 1981; Tomascik and Sander, 1985; Hallock and Schlager, 1986; Wittenberg and Hunte, 1992).

Coral reefs in Indonesia that comprises over 13.600 islands and has a coastline of about 81.000 km are very important for both subsistence and commercial fishing. One of the more prolific reef development in Indonesia is in Spermonde (Sangkarang) islands where this study was conducted. Most of these reefs, however, have been also subjected to human disturbances (see discussion in the next parts).

1.3. The Spermonde Archipelago

1.3.1. General description

Spermonde Archipelago is situated at the west off South Sulawesi, and consists of a large number of islands and shallow banks. The Spermonde shelf is separated by Makassar Straits from the Sunda shelf (see Appendix A). Moll (1983) noted that this shelf is a slightly east-west tilted plane with the higher edge on which the endmost islands are situated. The shelf abruptly drops to depths of more than 800 meters. At places, the isobath of 5 meters and 100 meters are less than a meter apart horizontally, at the outermost edge of the shelf around Kapoposan Island (Fig. 1.1).

The archipelago stretches northward for about 200 km and from Ujung Pandang city outward about 60 km. The total width of the area is about 16,000 square km (Noor, 1993). A map of the Spermonde Archipelago which shows the reef locations that will be discussed on this study is given in Fig. 1.1.

1.3.2. Meteorological Conditions

South-West Sulawesi is located at 5 °S latitude and is in the humid tropics. The mean monthly temperature is about 25.7 °C to 27.3 °C (see Appendix B) and minimum and maximum temperature averages are 22 °C and 30 °C respectively (Storm, 1989). The climate is monsoonal, with a wet and dry season. The wet season with the North-West monsoon begins in December and ends in March. The wettest month is January,

Figure 1.1. Map of the Spermonde Archipelago which shows the reef locations of the study area (Source: modified from Erftemeijer, 1994).

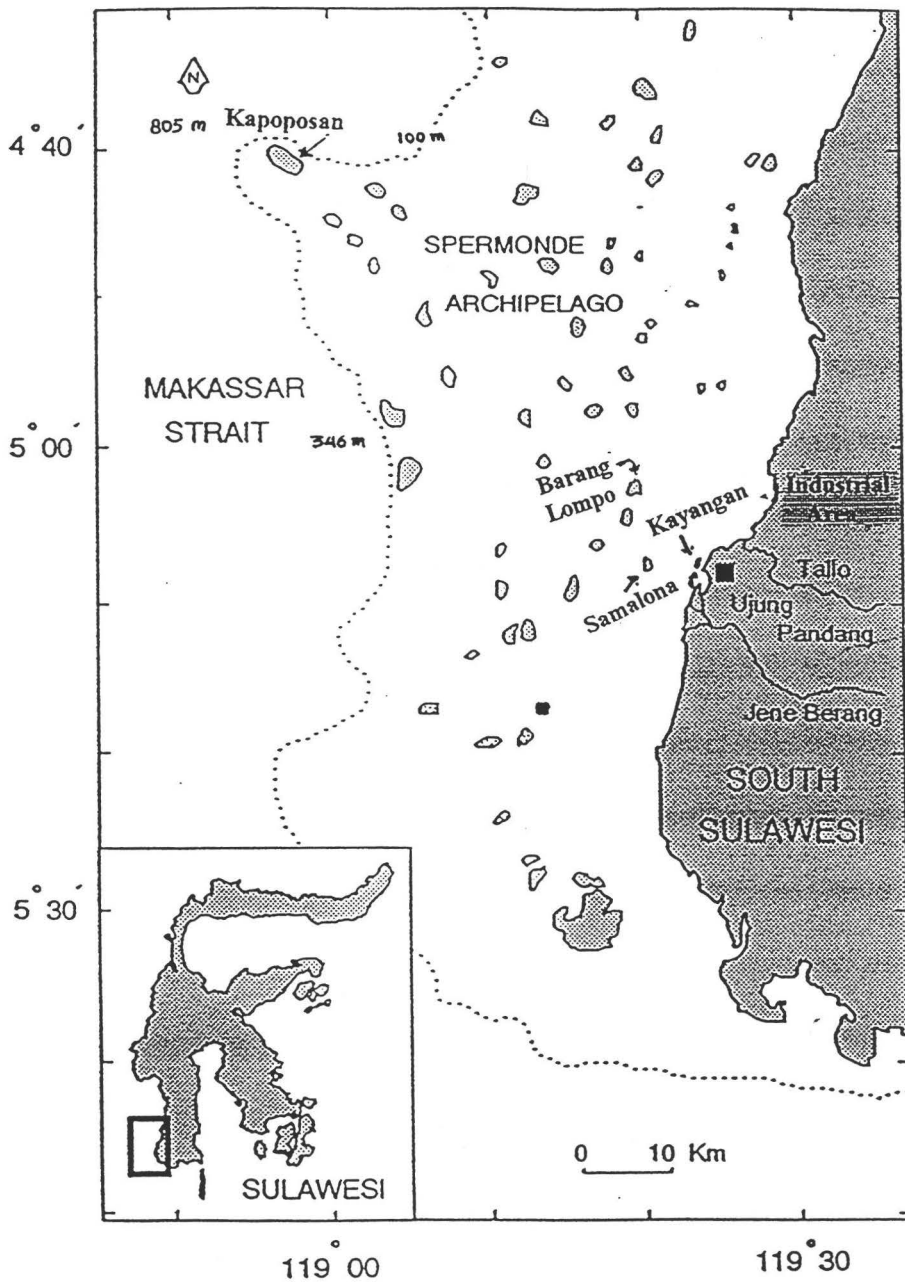

with 642 mm average rainfall. The dry season lasts from May to October during the South-East monsoon. The driest month is August, with 31 mm average rainfall (in 24 years, the month of August usually received no or very little rain, see Appendix C). In the wet season wind directions are from west to north-west, with a maximum velocity of 40 m/s. During the dry season, southern winds prevail, with maximum velocity 17 m/s (Storm, 1989). In April and November the monsoon changes and winds have a more variable direction. The average of monthly values of wind velocities (km/hr) at Ujung Pandang's vicinity from 1973 to 1995 is presented in Appendix D.

1.3.3. Oceanographic Conditions

Water in the Strait of Makassar flows to the south through the whole year (see Appendix A). The current is diverted to the East along the coast of South-West Sulawesi during the wet season. In the dry season, the current is diverted to the west, because of the inverted current direction on the Sunda shelf. On the shallow shelf of Spermonde Archipelago this results in a relatively strong southern (residual) current in the wet season and a weaker south-western (residual) current in the dry season (Moll, 1983 and Storm, 1989). For more detailed information about surface currents in February, April, June, August, October, and December around Sulawesi, see Fig. 1.2. from Wyrski (1961). The approximate geographic location of surface water types in the South Makassar Strait is also given in Fig. 1.3 (modified by Storm, 1989 from Wyrski, 1961).

Figure 1.2. Surface current around Sulawesi Island (From Wyrтки, 1961)

Notes : F = February
Ap = April
J = June
Au = August
O = October
D = December

Figure 1.3. The approximate geographical location of surface water types in the South Makassar Strait. The arrows indicate the general current direction of surface currents (redrawn by Storm, 1989 from Wyrтки, 1961).

Notes : A = East Kalimantan water
B = Upwelled water
C = Sulawesi coastal water
D = Jawa sea water

Fig. 1.2

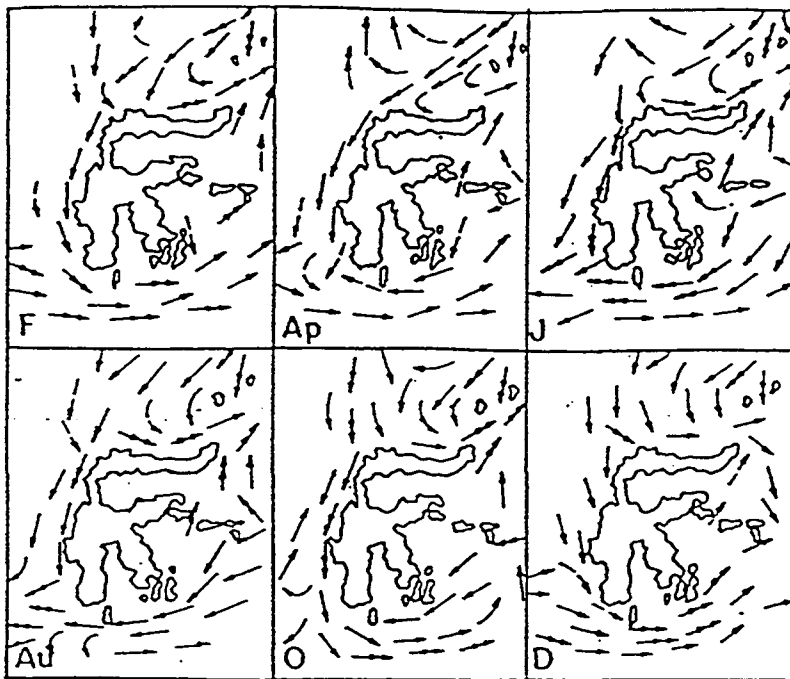
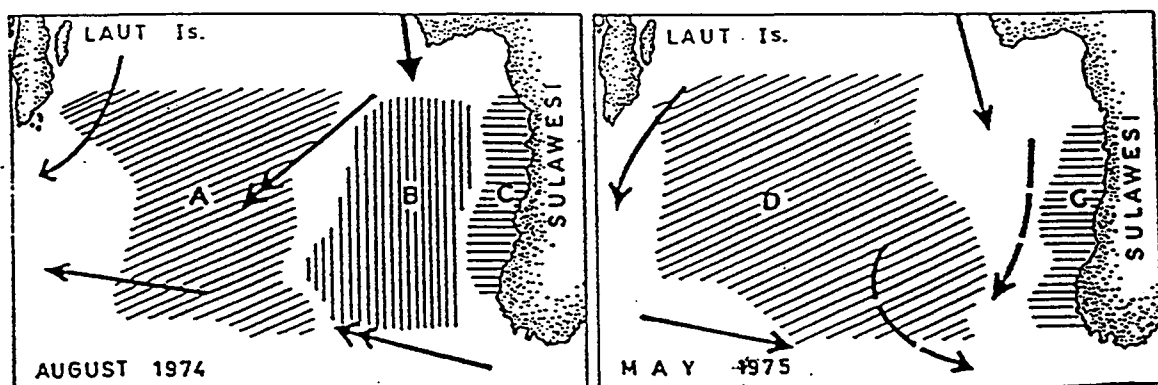

Fig. 1.3



Storm (1989) reported that the tidal wave in this area can be characterized as a mixed mainly diurnal tide. The maximum tidal amplitude is 170 cm (spring tide) and neap tide amplitude is about 30 cm. The waves observed on the shelf are wind waves. Prevailing wave direction is to the South-East or East during the wet season and to the North or North-East during the dry season. During the wet season larger swell waves from the Makassar Strait occasionally occur in the inner shelf

1.3.4. Previous Work

The earliest scientific work in this area was Umgrove (1930) who gave a description of the Spermonde Archipelago and mapped strips of morphologically similar islands, running north-south. He stayed in the East Indies (the name of Indonesia before become independent in 1945) from 1926 to 1929 as a government geologist. Other distinguished early workers in the area were de Klerk (1983) who studied oceanographic conditions, and Moll (1983) who did remarkable work on the study of zonation and diversity of scleractinia in the area.

The Indonesian-Dutch Snellius-II Expedition in September 1984 presented more comprehensive studies on coral reefs in eastern Indonesia, including Spermonde Archipelago (Land, 1989). Storm (1989) studied the influence of the Jene Berang river system and coastal hydrodynamics on the water quality during one monsoonal period in 1989. However, given the fact that coral reefs are very complex ecosystem and coral damage and deterioration in this area is being accelerated by the rapidly

developing city, more work on all different physical, chemical, biological, and ecological aspects is desperately needed.

1.3.5. Social and Economic Activities

Most of the islands in Spermonde Archipelago have been occupied since a long time ago. Some old 'retired' fisherman interviewed said even their great grand parents were born on these islands. Some of the islands, especially those close to Ujung Pandang, are densely populated, and the surrounding coastal environment sometimes looks 'ugly' because of garbage and sewage.

Most of the adult islanders are fisherman and some of them are traders, civil servants, craftsman, artisans, boat makers, and sailors. These traditional fisherman can be grouped according to different fishing scale; "big" and "small". The big fishing scale usually uses bigger boats, strong engine, bigger equipment such as big net, more facilities such as SCUBA and compressor (especially for sea cucumber fishing), or bring material for bombing, and bring more fisherman. Small scale fishing usually uses sailing boat with small equipment. However, because of the changing weather, most of them can not go fishing during severe winds that bring about big swell waves (usually in the beginning of wet season; August - September).

Despite the function of coral reefs as mentioned earlier, and despite the fact that most local people are heavily dependent on variety of reef and reef-associated animals, there are quite notable damages of coral reefs in most of the areas attributed

to human activities. One of the visible activity is that corals are being collected by the islanders for building material either for their own houses on the island or to be sold on the main land as construction material (mostly massive corals e.g. *Porites sp*, *Oulophyllia sp*). A few of them also harvest coral and sell them for the aquarium trade (mostly branching corals e.g. *Acropora sp*, *Seriatopora sp*, soft corals and sea anemones). The main cause of the reef destruction and damage in this area appears to be fish bombing. This activity is illegal in Indonesia, but control and law enforcement are still difficult and inefficient. Other causes are dropping anchor on delicate growth corals, walking on the reef, using cyanide, and other inappropriate fishing methods.

1.4. Study Scope and Objective

Different methods of monitoring and assessing coral reefs have been used (Chansang, 1984; Chou, 1984; Harger, 1984; Pedro *et. al.*, 1993; Dustan, 1993; Risk *at. al.*, 1993; and Lang, 1993). The basic goals of those studies of the monitoring and assessing of coral reefs were to give a “picture” of the status of selected areas in terms of their ecological, geological, biological, physical, chemical conditions and the internal and/or external factors or stresses that might be affecting the reef.

The objective of this study was to clarify the effects of sewage pollution and related pattern of coral reef degradation on present coral reef condition in affected site near Ujung Pandang city and offshore, relatively pristine reefs. Four sites were chosen

in the area, namely; Kayangan (affected site), Samalona, Barang Lompo, and Kapoposan as 'comparison' sites. Line intercept transects were used for benthic lifeforms of the reefs and coral diversity, and coral head (*Porites lobata*) banding was measured for growth rates. Water parameters measured were; salinity, clarity, phosphate, nitrate, ammonium, and chlorophyll *a*. Sedimentation was measured by SPM concentration and resuspended sediment. And $\delta^{15}\text{N}$ was used as an isotopic indicator of sewage pollution.

CHAPTER II

METHODOLOGY

2.1. Line Intercept Transect

This method was used to assess the sessile benthic community of the reefs based on structural attributes (lifeforms) rather than species level data. This method was developed in terrestrial plant ecology and subsequently adopted by coral ecologists (Loya, 1978; Marsh *et al.*, 1984; de Vantier, 1986; Risk *et al.*, 1993). Although it can not show the species diversity of the coral reef, it is quite useful and effective in describing the condition of coral cover with its basic character. Also it is capable of being used by person with little formal training (Risk *et al.*, 1993).

Both biotic and abiotic aspects of the reef under the tape were measured and characterized according to lifeform categories which provide morphological descriptions of the reef community (English, *et al.*, 1994). Lifeform categories, codes, and examples are provided in Append. E and the example features of the categories are shown in Append. F.

Before transects were made, snorkeling and or manta towing (see English, *et al.*, 1994) were done to obtain a general coral condition of the sites. 5 different 30 m-length transects were made both in 3 m and 10 m at all sites. The data were recorded to the nearest centimeter on underwater paper attached to a holder board.

2.2. Coral Growth Rates

Coral growth rates were determined by observing annual banding recorded in coral skeletons. Around 6-8 colonies of coral head (*Porites lobata*) were sampled at each site in about 2.5 m depth. Before removing from the substrate, the tops of the coral heads were “x” marked and then they were rinsed in fresh water before being air dried. One cm slabs were made by sawing down parallel to the major growth axis on the ‘x’ marks. These were X-rayed to ascertain the growth rate (Risk *et al.*, 1993). Similar methods was used previously by some workers, to name a few; Buddemeier *et al.*, (1974), Highsmith (1979), and Risk and Sammarco (1991).

Some of the X-rays were done in Wahidin S.H. Public Hospital of Ujung Pandang and some of them in Chedoke-Hospital McMaster University, Canada. The exposure condition were; 44 KV, 16 mA and source to film distance 115 cm. The dark color bands corresponded with less dense portion of the yearly growth couplet and lighter color corresponded with more dense skeletal.

2.3. Water Quality and Nutrients

Water quality and nutrients which were measured during this study (June to August 1995) were: salinity, water clarity, chlorophyll α , phosphate, ammonia, and nitrate. Salinity was measured by hand refractometer and clarity was measured by

secchi disk on the coral reef areas. Numbers of SPM samples, sediment traps, and other parameters that we measured in this study are given in Table 2.1.

Table 2.1. The sampling description and number of sampling at all study sites. SPM = suspended particulate matter; sed. traps = number of sediment traps; diss. nutr. = dissolved nutrients; clar. (secc) = clarity by secchi disk; sal. = salinity; chlo. a = cholophyll a ; $\delta^{15}\text{N}$ = number of coral tissue sample for nitrogen stable isotope measurement.

Sites	SPM	sed. traps	diss. nutr	clar. (secc)	sal.	chlo. a	$\delta^{15}\text{N}$
Kayangan (KY)	12	2	3	3	6	3	6
Samalona (SM)	12	2	3	3	6	3	8
Barang Lompo (BL)	12	2	3	3	6	3	9
Kapoposan (KP)	6	0	3	3	4	3	8

For dissolved nutrient (phosphate, ammonia and nitrate) analyses, one liter water was sampled and collected on each plastic container, treated with mercuric chloride, and brought to laboratories of Fisheries Dept. Hasanuddin University for analyses using spectrophotometer.

Chlorophyll a data were obtained from all sites three times during the study. Equipment used for sample preparation are: bucket, hand vacuum pump and apparatus, glass fiber filters, MgCO_3 solution, aluminum foil, and a cooler. 1-2 liter water were sampled from the depth of about 1 m. The sample then was filtered

through one of the glass fiber filters by hand vacuum pump. Before all the water had been filtered over or at the end of the filter cycle, few drops of MgCO_3 were added and after that the filter was fold in half, wrapped with aluminum foil and put in to the iced-container. Samples then were brought to the lab and keep in the freezer before having them analyzed. Chlorophyll *a* samples were analyzed using a spectrophotometer according to Parsons, *et al.*, (1984)

2.4. Suspended Particulate Matter (SPM)

SPM was sampled at all reef sites and around two outlet rivers, namely Jene Berang and Tallo rivers toward Samalona and Barang Lompo Islands (see Fig. 3-3 where the SPM samples around the outlet rivers were taken). At the time we collected the samples, the condition of waves at the sites were recorded. The equipment and material used in this sampling were: bucket, plastic water containers, preweighed Millipore 0.45μ filters (the filters were first washed in dilute HCl 1%, dried on crumpled aluminum foil and weighed), balance / OHAUS scale, vacuum pump, oven, and mercuric chloride solution. 12 repetition samples for Kayangan, Samalona, and Barang Lompo, 6 repetitions only for Kapoposan (too far for the author to make more repetition) and 2 repetitions were made from the river outlets outward.

After stopping the boat on the decided area, surface water was put into the plastic container, 1 ml mercuric chloride added, and brought to the laboratory. 1-1.5 liter sample then was filtered thorough preweighed Millipore 0.45μ filter by vacuum

pump and apparatus. The filters were then air-dried for a few hours and then dried at 80 °C overnight. After that, filters were weighed again. The difference between preweighed filter and the filter after filtering is the value of SPM (mg SPM per one liter water sample).

2.5. Resuspended Sediment

Resuspended sediment was taken by setting sediment traps on the coral reef sites. Two sediment traps were set in all sites but Kapoposan (the author was unable to set sediment traps in this site, however it can be consider that this site is unlikely to be influenced by sedimentation problem, because it is too far from the main land: see Fig. 1.1).

Sediment traps were constructed similar to English *et al.*, (1994) as shown in Figure 2-1. Each set of the trap had three traps which were attached at different high from the bottom; 25 cm, 50 cm, and 75 cm respectively. The trap was constructed from pieces of PVC pipe 7.8 cm centimeter internal diameter and 23.5 cm long. One end was sealed, and baffles were put on the top of the traps to deter settlement by fish. The traps were attached on the pole by strong rubber string, so they were easily removed but still strong and safe. The traps were placed on coral reef areas of about 3.5 m depth. There was no striking sign put near the traps to avoid local 'curious' fisherman from bothering or taking out the traps, but consequently the author usually had hard time to find the traps. The position of all the traps is provided on Figure 3-4.

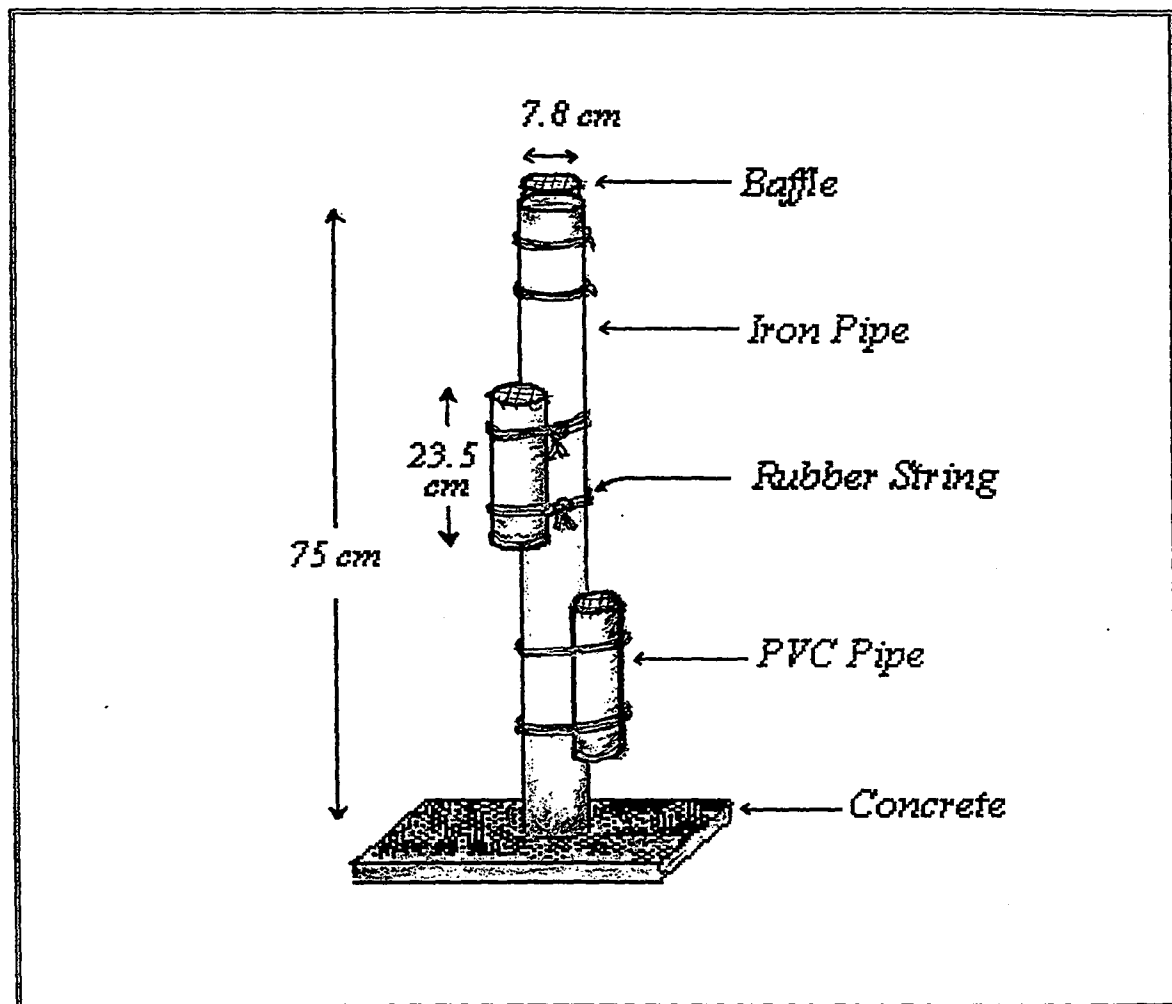

Figure 2 1. Sediment trap construction

Trapped sediments were collected weekly. Before removing the traps, the baffles were taken out and lids were put on to avoid sediment lost from the traps. Before putting back the traps, attached algae were cleaned off. All the water and sediment in each of the traps were transferred to each 1.5 liter plastic container, with 1 ml mercuric chloride added, and brought to the laboratory. The samples then were treated like SPM analyses but the filters were changed 3-4 times for each sample that contained high sediment loading.

2.6. Coral Diversity

The study of coral diversity was done separately from coral cover and lifeform transects, but still in the same area. In this study, the Line Intercept Transect method was used as well. About 20 to 60 m transects at 3-m and 10-m depth were made and the coral species composition underlying the transects were recorded. The coral species which could not be identified underwater were collected, labeled (e.g. *Montipora sp1*) and identified at the Hasanuddin University Marine Station in Barang Lompo using Veron (1986). All collections were kept at the marine station for use as sample references for students and staff. It is very important to provide coral samples at this place in order to protect student from taking too much coral sample during field studies (hundreds of students visit this area every year for field work).

Since I did not measure the number of colonies of each species, I can not apply biodiversity indices (such as; Shannon-Wiener's, Margalef's, or Simpson' Diversities)

(Smith, 1986; Barbour et. al., 1987). Instead, the total number of species found along the transect line and percentage number of species shared between depths will be presented in the next chapters.

2.7. Nitrogen Isotope Ratios ($\delta^{15}\text{N}$)

Six to nine tissue samples of coral heads (*Porites lobata*) were taken from 2-3 m depth at all sites. Coral skeleton with adherent tissues of about 75 cm² width and 2 cm thickness were chiseled from the coral head surfaces. The samples then were oven dried for 2 days at 80 °C and brought to McMaster University, Hamilton, Canada for nitrogen isotope analyses.

The samples were prepared following Dunn, 1995. Excess skeleton and greenish endolithic algal layer beneath the coral tissue was removed by a diamond circular saw. The remaining yellowish brown of tissue samples were then put in 1 l beakers with 25 ml 10 % dilute hydrochloric acid to dissolve the aragonite skeleton and free the tissue/ zooxanthellae. Additional dilute hydrochloric acid with higher concentration (to maintain the concentration about 10 %) was added when bubbling slowed, until the skeleton was completely dissolved. The remaining material was filtered through a fine nylon mesh and rinsed thoroughly few times with distilled water before being put into two tubes (one for replicate). Prior to sample freeze-drying, centrifugation was repeated two to three times and supernatant water removed from tissue pellet. 14 mg of each sample then was loaded into precombusted 6 mm

diameter Pyrex tubing along with an excess of cupric oxide as catalyst. The samples were combusted at 550 °C for 2 hours, one day before being analyzed. When sample admission to a VG Isogas SIRA mass spectrometer was run, CO₂ produced by combustion was frozen with liquid nitrogen, so only pure N₂ was analyzed by the spectrometer.

Organic standards (gelatin) and atmosphere standards were analyzed to estimate precision. The average precision based on these sample was 0.07 %.

δ¹⁵N results are reported in standard delta notation, as follows:

$$\delta^{15}\text{N in } \text{‰ units} = ((^{15}\text{N}/^{14}\text{N})_{\text{sample}} / (^{15}\text{N}/^{14}\text{N})_{\text{standard}}) - 1 \times 1000$$

2.8. Data Analyses

Benthic lifeform were calculated by using combination of Dbase III+ and Lf-form software made by Tuti and Rahmat (1993). This software was useful, especially for calculating the quite long transects that would be rather difficult to count manually.

Mann-Whitney test was applied to compare the parameters between station (Zar, 1974). SPSS statistic software version 6 for Windows (Norusis, 1994) and Minitab for Windows (McKenzie, 1995) were used to examine the statistical analyses. Excel 5 (Soucie, 1994) was used for spread sheets and graphs.

2.9. Study Sites

Four reef sites were chosen in this study: Kayangan, Samalona, Barang Lompo and Kapoposan. General description and assumed stresses for each site are presented in Table 2.2 (see also Fig. 1.1)

Table 2.2. General description and assumed stresses in study sites

Locations	General Descriptions	Assumed stresses
Kayangan	- about 0.2 km from mainland - near harbour and river mouths	- siltation - sewage
Samalona	- about 8 km from mainland - recreational place (uninhabited)	- anchoring - trampling
Barang Lompo	- about 12 km from mainland - site of Hasanuddin Univ. lab - dense populated island	- people (coral mining, trampling) - sewage
Kapoposan	- about 60 km from mainland - edge of the shelf - fewer people	‘ comparison ‘ (less stress from people and other factors)

CHAPTER III

RESULTS

3.1. Coral Cover

Coral cover is defined as percentage of live hard corals recorded along the transect line. Hard corals in this study are divided into two main groups; Acropora and Non-Acropora (English et. al., 1994). The pie charts of benthic communities of all sites at 3-m and 10-m are shown on App. G. A summary of benthic forms at all depths and sites can be seen in Table 3.1 and 3.2.

Table 3.1. The averages (m) of benthic communities at 3-m depths from five of 30 m transects. Total hard coral cover (in *Italic-bold*).

Benthic Life Forms at (3-m)	Kayangan ($n_1 = 5$)	Samalona ($n_2 = 5$)	B. Lompo ($n_3 = 5$)	Kapoposan ($n_4 = 5$)
Hard Corals (Acropora)	1.06 m	4.40 m	7.07 m	11.06 m
Hard Corals (Non-Acropora)	4.40 m	9.87 m	9.01 m	11.94 m
<i>Total Hard Coral Cover</i>	<i>5.46 m</i>	<i>14.27 m</i>	<i>16.08 m</i>	<i>22.99 m</i>
Dead Scleractinia	8.07 m	3.99 m	4.77 m	3.60 m
Algae	3.79 m	0.17 m	0.45 m	0.41 m
Other Fauna	2.74 m	1.80 m	2.34 m	2.27 m
Abiotic	9.95 m	9.77 m	6.36 m	0.72 m

Mann-Whitney tests show that total hard coral cover as shown in Table 3.1 at Kayangan Reef (affected site) at 3 m depth is the lowest coral cover compare to the

comparison sites (Mann-Whitney U, all $n = 5$, $40 \geq W \geq 32$, $P < 0.05$). On the contrary, Kapoposan reef shows a highest coral cover (22.9 m) (Mann-Whitney U, all $n = 5$, $40 \geq W \geq 32$, $P < 0.05$). This number is more than four times than that of Kayangan reef (5.46 m). Coral cover at Barang Lompo (16.08 m) is not significantly different (Mann-Whitney U, $n_1 \& n_2 = 5$, $W = 32$, $P < 0.05$) from that of Samalona (14.27 m).

Table 3.2. The averages (m) of benthic communities at 10-m depths from five of 30 m transects. Total hard coral cover (in *Italic-bold*).

<i>Benthic Life Forms</i>	Kayangan	Samalona	B. Lompo	Kapoposan
Hard Corals (<i>Acropora</i>)	0.00 m	1.75 m	2.37 m	1.76 m
Hard Corals (Non- <i>Acropora</i>)	2.95 m	10.76 m	9.14 m	14.55 m
Total Hard Coral Cover	2.95 m	12.51 m	11.51 m	16.31 m
Dead Scleractinia	3.42 m	4.87 m	4.85 m	3.55 m
Algae	0.6 m	0.02 m	0.72 m	3.32 m
Other Fauna	4.71 m	4.22 m	2.16 m	6.09 m
Abiotic	18.32 m	8.39 m	10.76 m	0.74 m

Mann-Whitney tests applied for all sites show that the lowest coral cover at 10-m depth is of Kayangan reef (2.95 m) (Mann-Whitney U, all $n = 5$, $40 \geq W \geq 15$, $P < 0.05$). It was also observed that this depth was the approximate maximum where coral can grow in this affected site. The bottom at this site was sand covered with

very fine sediment. Also, the visibility was so low that we could hardly see 1 m away. Other fauna commonly found on this site were Sponges.

As was the case at 3-m, the highest coral cover at 10-m depth was at Kapoposan reef (Mann-Whitney U, all $n = 5$, $40 \geq W \geq 15$, $P < 0.05$). The difference of that between Samalona and Barang Lompo was undetectable (Mann-Whitney U, n_1 & $n_2 = 5$, $W = 28.0$, $P > 0.05$). Nevertheless, coral damage at B. Lompo was seemingly worse than Samalona. As described earlier, Barang Lompo was a populated island, while Samalona is classified as a recreational place only.

The total hard coral cover from group *Acropora* at all sites and both depths are always less than that from group Non-*Acropora*. At 10m Kayangan reef, we could not even find any *Acropora*. Also, we found that the *Acropora* group was found much less at deeper reefs. The percentage of *Acropora* over total hard coral cover at 3m depth of station KY, SM, BL, and KP were 19.4%, 30.8%, 44.0%, and 48.1%, while at 10m depth were 0 %, 14.0 %, 17.2 %, 20.6 % respectively.

3.2. Growth Rates

The averages of coral growth-rates (mm yr^{-1}) at all stations are presented in Append. F and the curve is shown at Fig. 3.1. The number of measured years obtained from coral X-rays are different due to some unclear banding at earlier stages and the slightly different sizes of the corals themselves.

Figure 3.1. Coral (*P. Lobata*) growth-rates at all sites

Fig. 3.1 shows that growth rates of corals tend to fluctuate at all stations, but shows no clear growth trends related to the certain time (year). Statistical analysis shows that the highest (Man-Whitney U, $n_1 \& n_2 = 9$, $n_3 \& n_4 = 8$, $107 \geq W \geq 45$, $P < 0.05$) coral growth rates occurred at station BL (16.1 mm yr⁻¹). Man-Whitney tests show that *P. lobata* at station KY (affected site) grew faster than at station SM (Man-Whitney U, $n_1 \& n_2 = 9$, $W = 107.0$, $P < 0.05$) and KP (Man-Whitney U, $n_1 = 9 \& n_2 = 8$, $W = 102.0$, $P < 0.05$), while growth rate at station SM was statistically indistinguishable from that at station KP (Man-Whitney U, $n_1 = 9 \& n_2 = 8$, $W = 85.5$, $P > 0.05$). There were no significant growth rate trends over time. Means of coral growth rates, standard deviation, and sample sizes are given in Table 3.3 as follows:

Table 3.3. Means of coral growth rates, standard deviations and sample sizes at all stations.

Station :	Mean rate (mm yr ⁻¹)	Standard deviation	Sample size
B. Lompo	16.1	0.8	8
Kayangan	14.7	1.2	7
Samalona	13.7	0.5	6
Kapoposan	13.4	0.9	6

3.3. Coral Diversity

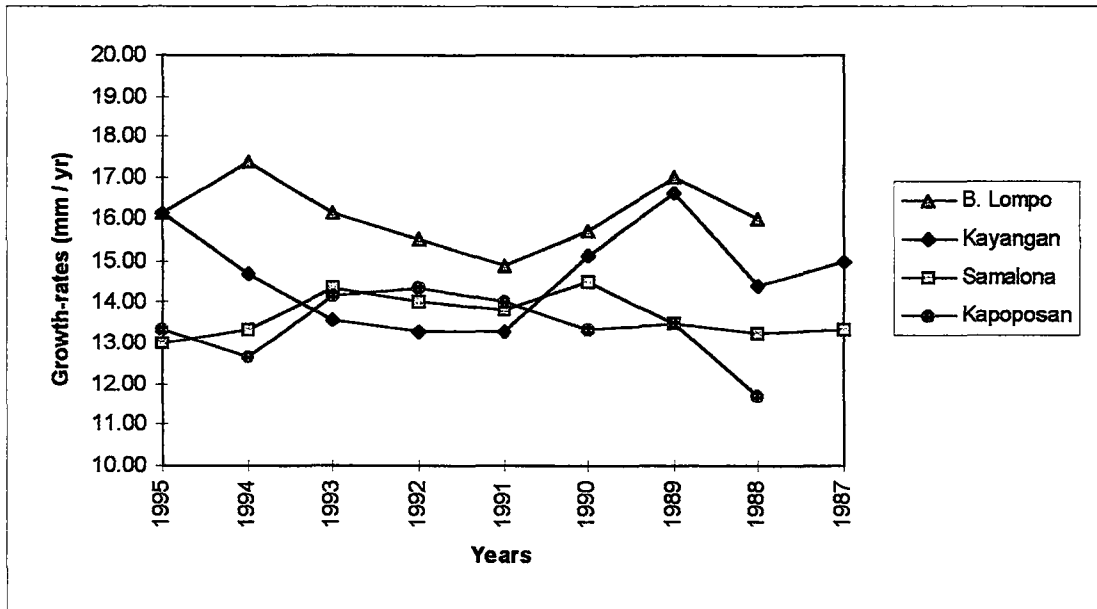
Number of species found at 3m and 10m depth, species shared between depths, and the total number of coral species are presented on Table 3.4 and species area curve is given on Fig. 3.2. Lists of coral species found at 3m and 10m at all sites are given in Appendix G.

The numbers of species are higher at 10m than those at 3m in all sites, except in Kayangan where number of coral species at 10m is very small (only 6) compare to 39 species at 3m depth. Surprisingly, the highest number of species at 3m depth among all the sites is at Kayangan. It was an unexpected result, considering the reef looked so bad with turbid water and low coral cover (this will be discussed related to coral cover, water quality, and dissolved nutrient in the discussion). Overall, the highest total number of species among the sites was at Kapoposan (80 species) and the lowest number was at Kayangan (39 species). Samalona and Barang Lompo had 62 and 71 species respectively. This result again shows that the further from the mainland the more total coral species were found in a given area.

Table 3.4. Total number of species and species shared between depths at all study sites

Site	Depth	Trsct. length	total spp.	10 m only	3 m only	both	% shared	total spp.
KP	10 m	40 m	65	52		13	20%	
	3 m	40 m	28		15	13	46%	<u>80</u>
BL	10 m	40 m	56	37		19	34%	
	3 m	40 m	34		15	19	56%	<u>71</u>
SL	10 m	40 m	54	31		23	43%	
	3 m	40 m	31		8	23	74%	<u>62</u>
KY	10 m	20 m	6	2		4	67%	
	3 m	40 m	37		33	4	11%	<u>39</u>

Figure 3.2. Number of coral species along the transect line (recorded every five meters).

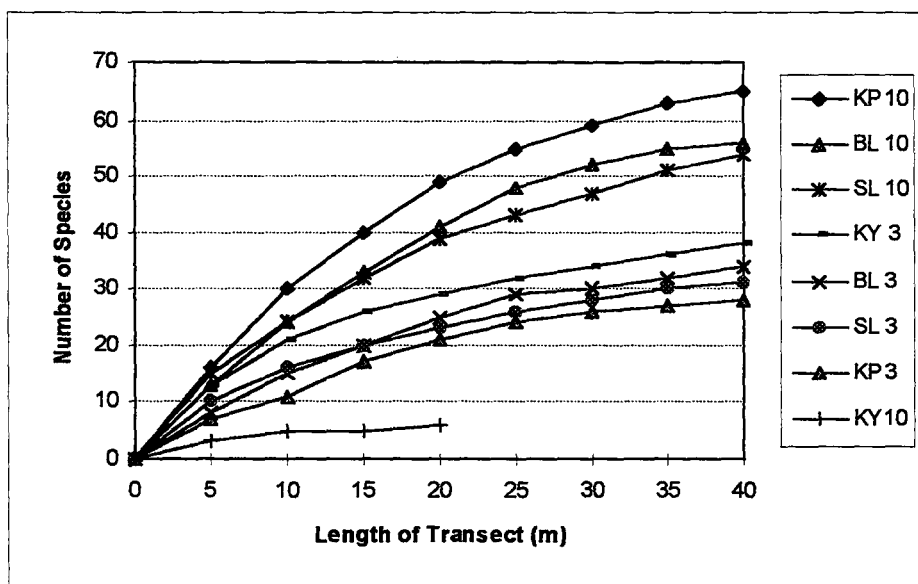

10m Kayangan transect was not continued more than 20m length because no more coral species could be found. In the case of transect length, some previous authors (Loya, 1972; Moll, 1983) used a ten meter transect line to compare the species area curve. They found that the number of coral species on the reef flat was less than that on reef edge. That mostly agreed with what we found, except in Kayangan.

3.4. Sediment

3.4.1. Suspended Particulate Matter (SPM)

The SPM contents of surface water at all sites during this study are presented in Table 3.5. From the table, it shows that the condition of sea surface at all sites but Kayangan, strongly influenced the concentration of SPM in the surface water. Therefore, we can simply assume that wave action can contribute to the SPM by stirring the fine particles at the bottom. The pattern of SPM concentration at Kayangan was slightly different than the other sites where, as shown in Table 3-5, SPM at this site was much higher in May and gradually reduced in the following months. Rainfall was strongly suspected as the cause of this higher SPM at the time, because as we observed, during this month the water turbidity was very low and we strongly believed that the color of this water was typically caused by sediment and particles swept out and carried by the rainfall outflow off to the ocean. Moreover, two rivers (as shown on the map) bring particles to the ocean not far from this site.

From Appendix B, we can also notice that the rainfall was still very high - which was not usual - on May 1995, this was the highest rainfall on May during the last 24 years.

Table 3.5. The value of SPM concentrations at all stations and condition of sea surface during sampling were recorded.

Dates (waves)	Locations			
	Kayangan (mg l ⁻¹)	Samalona (mg l ⁻¹)	Barang Lompo (mg l ⁻¹)	Kapoposan (mg l ⁻¹)
10/5 (calm)	25.13	10.38	8.32	-
16/5 (calm)	23.5	8.65	8.1	-
23/5 (calm)	18.6	7.15	6.97	-
30/5 (rough)	27.5	9.86	10.18	-
6/6 (rough)	23.4	8.44	8.26	-
13/6 (calm)	16.25	7.31	6.2	-
19/6 (calm)	14.62	6.75	7.67	-
25/6 (rough)	20.44	9.58	10.18	-
3/7 (calm)	14.35	7.64	8.11	-
9/7 (rough)	16.8	7.5	11.32	-
16/7 (calm)	15.88	6.35	7.46	-
19/7 (calm)	-	-	-	4.12
20/7 (calm)	-	-	-	3.95
23/7 (rough)	14.5	9.02	10.76	-
16/8 (rough)	-	-	-	5.33
17/8 (rough)	-	-	-	4.89
29/8 (rough)	-	-	-	6.03
30/8 (rough)	-	-	-	7.25
Average ± SD	19.25 ± 4.61	8.22 ± 1.30	8.62 ± 1.60	5.26 ± 1.24

The result shows that the mean SPM concentration at all sites, except at Kayangan reef, were less than 10 mg l⁻¹, and not subject to stresses from human activities as suggested by Rogers (1990). However, those values were obtained mostly in dry season, so we assume that those values would be higher during rainy season, especially in Kayangan reef.

SPM sampling was also done in the river mouths outward to Samalona and Barang Lompo Islands as well as along the coast of Ujung Pandang between the two rivers. Unfortunately, we sampled in June and July when the rainfall records were low (see Append. B). The average values of SPM concentration put on approximate sampling location is presented on Fig. 3.3.

3.4.2. Resuspended Sediment

Resuspended sediment was measured for 12 weeks (May 23 - August 8) at three sites only; Kayangan, Samalona, and Barang Lompo. The averages of all data are presented weekly in Table 3.6 and the graphs for each height of traps (from the bottom) can be seen on Fig. 3.4. Among the three stations, resuspended sediment collected at station KY was significantly highest (Mann-Whitney U, all $n = 12$, $222 \geq W \geq 148$, $P < 0.05$) at all heights (75, 50, and 25 cm from the bottom sediment), while resuspended sediment at station SM was statistically indistinguishable from that at station BL (Mann-Whitney U, n_1 & $n_2 = 12$, $W = 149$, $P > 0.05$). The highest resuspended sediment at station KY could result not only from resuspension per se, but also from sediment input by runoff during the rainy season.

Resuspended sediments ($\text{mg cm}^{-2} \text{d}^{-1}$) between heights at all stations show no significant difference (Mann-Whitney U, all $n = 12$, $159.5 \geq W \geq 130.5$, $P > 0.05$). Again, if we assume that the sediments settled at sediment traps were only resuspended

Figure 3.3. The average values of SPM concentration on June and July 1995.

Note : ✕ = sediment trap locations

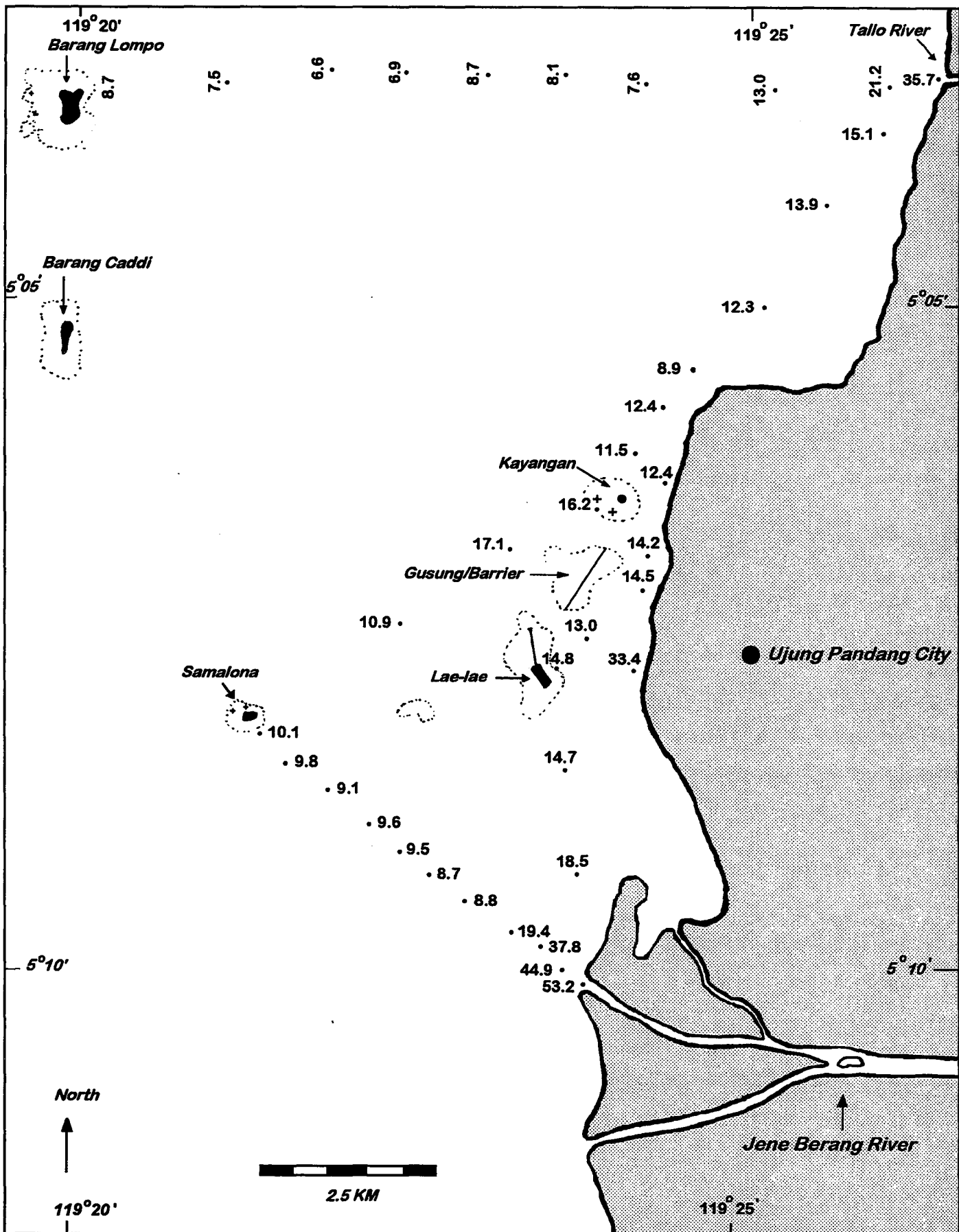
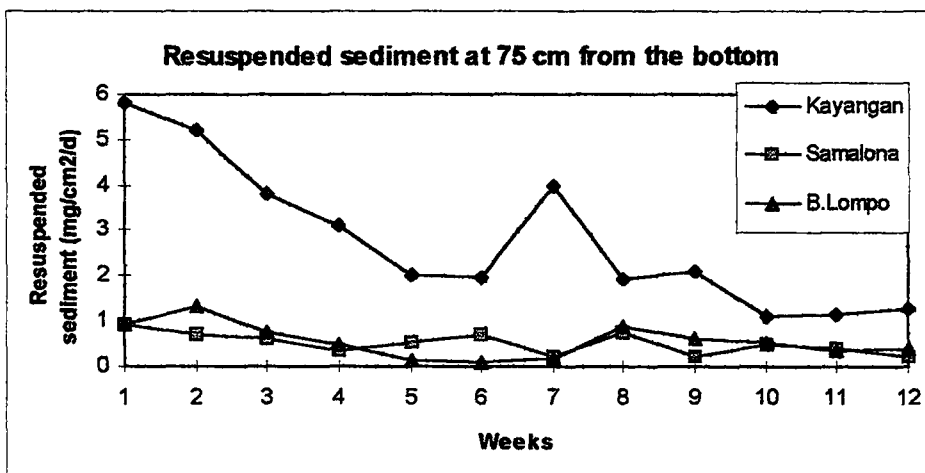
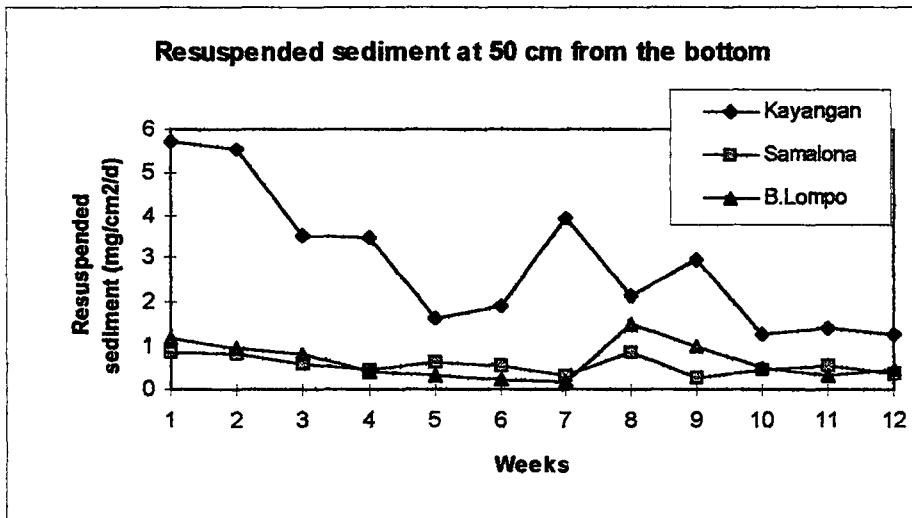
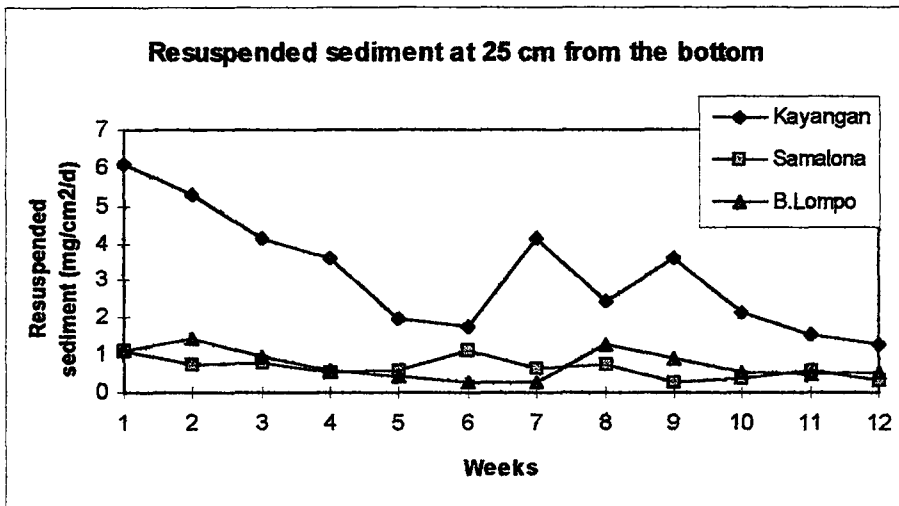

Fig. 3.4. Resuspended sediment graphs at different height (25, 50, and 75 cm) from the bottom. The traps were set in Kayangan, Samalona, and Barang Lompo reefs for 12 weeks (May 23 - August 8, 1995).



bottom sediment, we would expect that the lower traps would trap more sediment than the higher traps. On the other hand, the upper traps could have intercepted surface SPM that was undergoing lateral transport.

Table 3.6. The average values of resuspended sediment ($\text{mg cm}^{-2} \text{d}^{-1}$) at each different height from the bottom.

Station	75 cm	50 cm	25 cm	Average
Kayangan (KY)	2.7	2.8	3.0	2.8 ± 0.2
Samalona (SM)	0.5	0.6	0.6	0.6 ± 0.1
B. Lompo (BL)	0.6	0.7	0.7	0.7 ± 0.1
Average	1.2	1.4	1.5	

To understand more comprehensively about sedimentation mechanism in this area, more interactive and long period of studies regarding current, waves, winds, tides and river discharges are really needed.

3.5. Sea Water Quality and Dissolved Nutrients

3.5.1. Chlorophyll *a*

The results of chlorophyll *a* measurement are presented on Table 3.7. Those concentrations were relatively lower (usually lower than $1 \mu\text{g l}^{-1}$) than those Erftemeijer (1994) reported from the adjacent area. Mann-Whitney tests applied to differentiate between the stations show that the highest concentration of chlorophyll *a*

was at station KY (Mann-Whitney U, all $n = 3$, $15 \geq W \geq 14$, $P < 0.05$) and those at station SM and BL were higher than that at station KP (Mann-Whitney U, all $n = 3$, $15 \geq W \geq 14$, $P < 0.05$). While there was no significant difference between station SM and station BL (Mann-Whitney U, n_1 & $n_2 = 3$, $W = 14$, $P > 0.05$).

Table 3.7. The values of chlorophyll concentrations in sea water column (Standard deviations are given).

	I	II	III	Average \pm Stand.Dev.
Kayangan (KY)	1.9008	0.9126	1.7537	1.5224 \pm 0.53
Samalona (SM)	0.7654	0.8262	0.8599	0.8172 \pm 0.05
B. Lompo (BL)	0.7423	0.695	0.8256	0.7543 \pm 0.07
Kapoposan (KP)	0.4353	0.5286	0.438	0.4673 \pm 0.05

3.5.2. Sea Water Clarity

Sea water clarity values at all station measured by secchi-disk readings (m) are presented in Table 3.8. All stations, except KY were characterized by clear water with high sechi-disk readings (13.4 m to 24.25 m). Clarity at stations KY, SM, and BL gradually improved with time, because rain in May was still considerably high. Especially at station KY, rainfall seriously affected the water clarity and of course it would do so to the coral reef development at the area. Elevated levels of turbidity and sedimentation have been found to reduce calcification rates and coral growth, presumably by decreasing light availability for photosynthesis or increasing energy demands of the coral for sediment rejection (Aller and Dodge, 1974; Bak, 1978;

Dallmeyer et al., 1982; Rogers, 1990). Recent study on effects of turbidity on P : R ratio (Telesnicki and Goldberg, 1995) implies that higher turbidity increases respiration process.

Table 3.8. The values of water clarity at all station (measured as secchi-disk readings in *meter*)

Stations :	mid-Jun	mid-Jul	mid-Aug	Average \pm SD
Kayangan (KY)	3.7 m	5.4 m	6.1 m	5.1 m \pm 1.2
Samalona (SM)	13.4 m	16.3 m	18.2 m	15.9 m \pm 2.4
Barang Lompo (BL)	14.5 m	13.5 m	16.9 m	14.9 m \pm 1.7
Kapoposan (KP)	21.9 m	24.3 m	22.9 m	23.0 m \pm 1.2

Man-Whitney tests applied for those values show that the highest clarity (m) occurred at station KP and the lowest clarity was at station KY (Man-Whitney U, all $n = 3$, $11 \geq W \geq 6$, $P < 0.05$). There were no significant difference between clarity at station SM and BL (Man-Whitney U, all $n = 3$, $W = 10$, $P > 0.05$).

3.5.3. Salinity

The salinity was mostly constant, except in the first two weeks at Kayangan reef (see Table 3.9). On May, there were still rainfalls that caused lowered surface salinity in all sites. Storm (1989) recorded that the salinity of water surface around Kayangan in the rainy season (December - March 1989) could reach around 20 ‰; at the same time, the low salinity could also reach out to Samalona Island.

Table 3.9. The value of salinity (‰) measured during this study at all stations. Average values \pm SD are also given.

Stations :	(mid-May)	(early-Jun)	(mid-Jun)	(early-Jul)	(mid-Jul)	(early-Aug)	Average \pm SD
Kayangan	29.5	31	32	32	31.5	32.5	31.4 \pm 1.1
Samalona	32	33	33	33.5	33	33.5	33.0 \pm 0.5
Barang Lompo	32	34	33.5	33.5	34	33.5	33.4 \pm 0.7
Kapoposan	-	-	33.5	33.5	33	34	33.5 \pm 0.4

Mann-Whitney tests show that the salinity at all stations, except at Kayangan, were not statistically different (Mann-Whitney U, $n_1, n_2, n_3 = 6, n_4 = 4, 29 \geq W \geq 21, P > 0.05$). However, the lowest salinity at Kayangan (Mann-Whitney U, $n_1, n_2, n_3 = 6, n_4 = 4, 29 \geq W \geq 21, P < 0.05$) seemed to be just seasonal (influenced by heavy rain), because in the months of June to August, the salinities were relatively the same. The salinity recorded during this study were still within the range of tolerance limit (25 - 40 ‰) for hermatypic coral (Yonge, 1986; Newell, 1972).

3.5.4. Dissolved Nutrient

Dissolved nutrients measured in this study were phosphate, nitrate, and ammonium. Our number of samples, however, were small and the period of time very short. In general, the concentration of those nutrient in water column at all station were low ($< 1 \mu\text{M}$). The average concentrations and standard deviation (in parentheses) of dissolved nutrients at all stations are given in Table 3.10.

Table 3.10. The value of dissolved nutrient concentration (μM); phosphate ($\text{PO}_4\text{-P}$), nitrate ($\text{NO}_3\text{-N}$), and ammonium ($\text{NH}_4\text{-N}$). The values are average \pm SD from three samples series.

Stations	$\mu\text{M PO}_4\text{-P} \pm \text{SD}$	$\mu\text{M NO}_3\text{-N} \pm \text{SD}$	$\mu\text{M NH}_4\text{-N} \pm \text{SD}$
Kayangan (KY)	0.407 ± 0.19	0.848 ± 0.23	0.984 ± 0.30
Samalona (SM)	0.310 ± 0.10	0.485 ± 0.03	0.268 ± 0.04
Barang Lompo (BL)	0.304 ± 0.11	0.631 ± 0.13	0.273 ± 0.07
Kapoposan (KP)	0.184 ± 0.03	0.341 ± 0.07	0.145 ± 0.13

Coral reef environments are generally regarded as having low dissolved nutrient concentrations (Crossland (1983); Risk and Muller (1983); Smith (1984); Tomascik and Sender (1985); Erftemeijer (1994)). Concentrations of phosphorus and nitrogen have received most attention because those compounds are the fundamental supply for tissue growth. However, Kinsey and Davies (1979) stated that elevated nutrient concentration (especially phosphate) can suppress coral reef calcification directly. The concentration of nutrient enrichment that Kinsey and Davis (1979) used in this study, nevertheless, were much higher ($2 \mu\text{M}$ phosphate and $20 \mu\text{M}$ ure + ammonium as nitrogen source) compared to the results that we measures (Table 3-10).

Man-Whitney test indicates that the values of phosphate at all stations show no significant difference, even after log-transformation (Man-Whitney U, all $n = 3$, $14 \geq W \geq 11$, $P > 0.05$). This is due to the high heterogeneity of phosphate data. However, simple linear regression analysis shows that there is a significant trend ($F=5.45$, all $n = 3$, $P < 0.05$) of gradient of phosphorus at four sites from mainland with

equation; phosphate concentration (μM) = $0.615 - 0.084 \log$. distance from mainland (km) (see Append. J for graph and statistical analysis).

The highest nitrate value among all study sites occurred at station KY and BL (Mann-Whitney U, all $n = 3$, $15 \geq W \geq 14$, $P < 0.05$ for all comparisons), but nitrate concentration at station BL was not significantly different from that at station KY (Mann-Whitney U, n_1 & $n_2 = 3$, $W = 14.0$, $P > 0.05$). Concentrations of nitrate at stations KY, SM, and BL were significantly higher than those at station KP (Mann-Whitney U all $n = 3$, $15 \geq W \geq 14$, $P < 0.05$).

The highest ammonium concentration among all the study sites, again occurred at station KY (Mann-Whitney U, all $n = 3$, $15 \geq W \geq 12$, $P < 0.05$) which is the closest station to Ujung Pandang city. The concentrations of ammonium at station SM, BL and KP were not discernibly different (Mann-Whitney U, all $n = 3$, $15 \geq W \geq 12$, $P > 0.05$).

The overall nutrient level measurement during this study at all sites shows that Kayangan reef has higher nutrient levels (eutrophic) than the other sites, while Kapoposan reef was relatively more oligotrophic and Samalona and Barang Lompo have similar intermediate nutrient levels.

3.6. Nitrogen Isotope Ratios ($\delta^{15}\text{N}$)

$\delta^{15}\text{N}$ values of all coral samples in this study are given in Table 3.11, with regression fit in addition to log distance from mainland (km) in Append. K. Nitrogen isotopic ratio of Kayangan, Samalona, B. Lompo and Kapoposan corals range from

7.5 - 9.0 ‰, 4.3 - 7.1 ‰, 4.1 - 7.8 ‰, and 3.6 - 5.2 ‰ respectively. Mann-Whitney test reveals that the highest (Mann-Whitney U, $n_1 = 6$, $n_2 = 8$, $n_3 = 9$, $95 \geq W \geq 55$, $P < 0.01$) $\delta^{15}\text{N}$ values is at Kayangan (affected site) with average value 8.0 ‰. Similar trend was found in Maldives by Risk et. al., 1993, where $\delta^{15}\text{N}$ values are higher at affected sites than those at comparison sites. There is no statistical difference between $\delta^{15}\text{N}$ values from Samalona and B. Lompo (Mann-Whitney U, $n_1 = 8$ & $n_2 = 9$, $W = 89$, $P > 0.05$). $\delta^{15}\text{N}$ values in Samalona are significantly higher than those in Kapoposan (Mann-Whitney U, n_1 & $n_2 = 8$, $W = 88$, $P < 0.05$), while these values in B. Lompo are not significantly higher than those in Kapoposan (Mann-Whitney U, $n_1 = 9$, $n_2 = 8$, $W = 95.0$, $P > 0.05$).

Table. 3-11. $\delta^{15}\text{N}$ values (‰) of all coral samples at all sites

Sample	Kayangan	Samalona	B. Lompo	Kapoposan
1	7.8	4.9	4.1	4.5
2	8.3	4.9	4.5	3.6
3	9.0	4.3	6.9	4.0
4	7.5	6.2	7.8	3.6
5	8.3	5.3	4.6	3.7
6	7.3	7.1	4.8	5.1
7		4.9	4.2	4.4
8		4.9	4.1	5.2
9			4.4	
Average :	8.0	5.3	5.0	4.3
STDEV	0.6	0.9	1.3	0.6

Simple linear regression analysis on nitrogen isotope gradient in addition to log distance from mainland (App. H) reveals a significant trend ($F = 56.35$, $P < 0.001$), with equation $\delta^{15}\text{N}$ values = $11.349 - 1.534 \log$ distance (km) and $R^2 = 0.660$.

CHAPTER IV

DISCUSSION

4.1. Coral Reef Conditions and Environmental Factors

Coral cover, growth rate and number of species are used as parameters in this study to assess the condition of coral reef. Correlation coefficients (r) among those parameters were calculated to examine the connection among them. To approach the possible factors quantitatively that may have strong connection to the coral reef condition, correlation coefficient were also tested between those parameters of coral condition and some environmental parameters, that is, SPM (mg/l), salinity (‰), clarity (meter-secchi disk), chlorophyll a ($\mu\text{g l}^{-1}$), and dissolved nutrient ($\text{PO}_4\text{-P}$, $\text{NO}_3\text{-N}$, and $\text{NH}_4\text{-N}$) in μM units. The values of coral cover tested were the averages between 3 and 10 m, while species numbers were tested as a total number of species at each station (see Appendix L.1 for the coefficient correlation (r) values).

The general expectation about a coral reef being in good condition considering the above parameters are high coral cover, high growth rate, and high number of species. However, external factors, whether natural or human-induced disasters (Cortes and Risk, 1985; Ongkoso and Sukarno, 1986; Vantier, 1986; Willoughby, 1986; Tomascik and Sander, 1987; Montaggioni *et al.*, 1993) or combinations of them, would result in changes in the pattern of their biological, chemical, physical or ecological condition. One factor might affect only one or two or even all the coral

parameters. For instance, fish blasting at coral reef area would usually destroy the ‘fragile’ corals within certain radius. This would automatically decrease the coral cover, but it does not necessarily mean that it would decrease coral growth or number of species at the given area, at the same time.

From Append. L.1, Spearman Rank correlation between coral cover, growth rate, and species number show that there was no correlation between growth rate and species number ($r = -0.285$, $P > 0.05$) and between coral cover and growth rate ($r = 0.448$, $P > 0.05$). The only significant correlation ($r = 0.981$, $P < 0.05$) was between coral cover and species number, where – as previously mentioned – the highest coral cover and total species number was at station Kapoposan and the lowest one in those values was at station Kayangan. This implies that there were some factors that significantly suppressed the coral cover and species number at Kayangan, which do not significantly affect the other sites. Given the fact that Station Kayangan is very close to Ujung Pandang city and there are two big rivers relatively close to it, as well as some harbours along the coast of U. Pandang city (local inter-island jetty, big regional harbour, navy harbour and fisheries harbour), we suggest that sedimentation and eutrophication (pollution and sewage) are the main ‘stress’ factors to coral damage at station Kayangan. Our data on environmental variables mostly agree with this suggestion (see Chapter III). The summary of coral reef condition and environmental variables is presented on Append. L.2

The high chlorophyll *a* concentration at station Kayangan supports the conclusion that this site was likely affected by humans, because chlorophyll *a* is considered as a very reliable indicator of eutrophic environment (Smith et al., 1981; Bell, 1991; Lapointe and Clark, 1992). Also, chlorophyll *a* could be useful natural tracer for bioavailable nutrient (Dunn, 1995).

The results of SPM measurement around the river outlets show that the SPM concentration were high at the river outlets and gradually decrease toward the ocean. Also, it seemed that the extension of river plume during the observation (June and July) at both river outlets was low. The spatial distribution of SPM concentration (from Table 3.5 and Figure 3.3), however, does not show a clear pattern. Sources of SPM in addition to the river plume could be from mechanical fractionation of coral skeleton fragments and resuspension of sediment caused by wave action on the reefs (Storm, 1989) and biological erosion (bioerosion) by echinoids, gastropods and fishes (Hopley, 1983; Rose and Risk, 1985).

The fact that SPM concentration is higher at Kayangan reef than closer to Ujung Pandang city might be caused by currents and waves that resuspend the sediment from the seabed and cause an increase in SPM in the whole water column by turbulence. This process is more intense at shallow Kayangan reef, but less intense in the water column between Kayangan and Ujung Pandang city (see Fig. 3.3).

The average value of resuspended sediment at Kayangan reef at all depths (2.8 mg cm⁻² d⁻¹) was significantly higher than that at Samalona and Barang Lompo reefs. However, it was considered by Rogers (1990) as not subject to stress from human

activities (less than $10 \text{ mg cm}^{-2} \text{ d}^{-1}$). However, that value at Kayangan reef was also higher than those in Dodge et. al., (1974) and Rogers (1983). Moreover, this study was conducted mostly in dry season when sediment loading from the mainland was lower.

4.2. Coral Cover and Number of Species

Total hard coral cover found in this study increases with the distance from the mainland. However, we cannot simply conclude that the further from the mainland the better the reef will be, because many factors might play roles interactively. Furthermore, based on our preliminary observations on the other islands around this Archipelago, there were some farther islands from Samalona and Barang Lompo that seemed to have worse coral reef conditions even though some of them were not inhabited islands (Kodingareng Keke and Bone Batang). I observed that most coral reefs in uninhabited islands in this archipelago were suffered from bombing activities.

There is a possibility that coral cover and species richness may be autocorelated: i.e., obviously one cannot count coral species on a sand patch. For this reason, therefore, I have based most of my discussion re richness on the species-area curves, which were run in areas of relatively flourishing coral development.

Stress factors (natural or human induced), coral cover and number of species are generally believed to have a strong negative correlation. Heavy sedimentation, for example, is associated with fewer coral species, less live coral and reduced coral

recruitment (Cortes and Risk, 1985; Rogers, 1990). Resuspended sediment, dissolved nutrient, and other environmental variables measured indicate that sedimentation and eutrophication (sewage and pollution) were significantly higher at station Kayangan which was the closest site to the mainland.

Those 'stress' factor could decrease coral cover and number of species, because they reduced light availability for photosynthesis (limiting coral distribution), smothered coral, and lowered coral recruitment (Tomascik and Sander, 1987; Withenberg and Hunte, 1992; Rogers, 1990; Aller and Dodge, 1974). The very significantly lower ($P < 0.05$) level of clarity at station Kayangan (± 5.07 m) recorded during the study was also the main cause of the very low coral cover and number of species, especially at deeper reefs. The very low light availability restricts the coral development in this area to the maximum depth (± 10 m). Surprisingly, we found that the number of species at 3m depth at Kayangan was very high (43 species). Nevertheless, from the appearance of corals at this site, it seemed that coral reef in this site was seriously affected by sedimentation and eutrophication (sewage and pollution).

The possible answer to this phenomenon is low intraspecific coral competition for spaces (Rinkevich and Loya, 1982; Thomason and Brown, 1986; Hidaka and Yamazato, 1984; Chadwick, 1988), because the low coral cover on this site would decrease the intraspecific competition among the hermatypic corals.

The main factors presumably constituted to the lower coral cover and number of species at Samalona and Barang Lompo (compared to Kapoposan), were human

factors (anchoring, fish bombing, or coral harvesting) and sewage, possibly another factor affecting Barang Lompo. In most cases, anchoring, foot-stepping, fish blasting, and wave action traces on coral reefs can be distinguished from their characteristics. Anchoring on fragile coral reef usually causes localized coral damage where the anchor is moored and leave a small rubble patch. Foot-stepping or human physical contact usually cause broken fragile coral tips. Fish bombs usually cause a localized, severe coral damage for all coral forms, even massive forms. The radius of the damage vary depending on the strength of the bomb (usually 5-20 m square) and the traces usually in forms of coral rubble patches surrounded by life corals. Traces of coral damage caused by wave actions usually in forms of broken fragile corals that spread over a wider area.

Barang Lompo island, as mentioned earlier, was a dense populated island and many student and other visitors always come to this island for field work or recreation. There were many traces of fish blasting, anchoring, foot-steps or human related coral damage found at this site. Further, we got some information that some local fisherman used gill-nets and potassium cyanide on the coral reef area to catch ornamental fishes for commercial purposes. Also, local fisherman collected corals (mainly soft corals) to sell to the special 'agent' collector at this island and they were sent to the city for aquaria. Those activities have been going on since a few years ago and of course, it would be a serious threat for the future of coral reef at the area if there is no control or regulation imposed to protect the reef.

Samalona Island has been claimed by government as a public recreational place and proposed as a marine park. As a consequences, however, a lot of visitors (local and tourist) come to this area for snorkeling, diving, and fishing. Anchoring visitors' boats on the reef area has destroyed a lot of 'fragile' corals. Many small patches of coral rubbles were observed which we believe were caused by anchoring. Surprisingly, we found some fish blasting traces with considerably wide rubble patches and some big massive coral (*Porites lobata*) upside down. If fish blasting happened on this restrictive island for commercial fishing which is relatively close to the city, what about the rest of the islands? Human factors, therefore, should also be considered as an important aspect of coral reef management on this area, in addition to sedimentation and eutrophication as well as other natural disturbances.

The high coral cover and number of species at Kapoposan were supported by the less sedimentation, eutrophication and human interference. However, natural disturbances like wave action, and human-induced factor like anchoring and fish blasting were also found. Again, this indicates that the human factor is very important for coral reef development.

4.3. Growth Rates

Coral growth rates found in this study were relatively higher than those at Zanzibar and Maldives found by Risk *et al.*, (1993) on *P. lobata*. Further, they found that coral growth rates at affected sites were higher than at control sites. In this

regard, we can see a similar phenomenon if we compare between station KY (affected site) and SM and KP ('control' sites). Nevertheless, the fact that the highest coral growth rates occurred at station BL implies more complicated affecting the coral growth rates.

Append. L.1 shows that there is no significant correlation coefficient (r) between growth rate and environmental variables. This implies that other variables influenced coral growth. Regardless, the highest correlation coefficient between environmental variables and coral growth tested, was with Nitrate ($r = 0.69$). This may be an indication that nutrient play an important role in coral growth rate.

There have been a lot of previous studies regarding coral growth. Some implicitly assumed that coral growth decreased with the increased of 'stress' factors (Montaggioni et al., 1993; Kinsey and Davis, 1979; Hallock and Schlager, 1986; Cortes and Risk, 1985; Rogers, 1990; Aller and Dodge, 1971). On the contrary, some found that sewage stress as a nutrient enrichment could increase coral growth rate (Risk, et. al., 1993) and other found faster growth and larger size of coral juveniles in eutrophic area (Wittenberg and Hunte, 1992). Also, Tomascik and Sander suggested that SPM up to a certain maximum concentration may play a role as an energy sources for increasing coral growth..

The result of this study shows that the differences in coral conditions among the sites were mostly significant ($P < 0.05$) and so were environmental factors. Resuspended sediment, SPM, dissolved nutrient and chlorophyll a recorded during the study indicated that they were considerably higher at station Kayangan than those at

other stations. Again, there were other indications of those 'stress' factors by sedimentation and sewage. On the contrary, however, coral growth at this affected station was significantly higher than stations Samalona and Kapoposan, which had less nutrient concentrations than Kayangan. This presumably implies that the so-called 'Janus Effect' (Edinger, 1991) occurred in this area, where nutrient enrichment up to a certain maximum, enhanced coral growth rate. The fact that the highest growth rate occurred at station Barang Lompo might be related to 'the maximum nutrient enhancement. Nutrient levels higher than a critical level, would inhibit the reef growth, due to the increase of bioerosion, alga competition, and carbonate crystal poisoning (Kinsey and David, 1979; Glynn and Wellington, 1983; Hallock and Schlager, 1986; Birkeland, 1987; Montaggioni, 1993). Nevertheless, a recent study by Atkinson et. al., (1995) indicates that corals can and do flourish in relatively high-nutrient water. They stated further that the coral growth does not appear to be inhibited at concentrations of nitrogen up to 5 μ M. Given the fact, however, that their study was conducted in an aquarium, it is still difficult to explain what processes govern the growth of these organisms, because there might be differences between conditions in the aquarium and the ecologically complex natural condition of the reef. Therefore, the effects of nutrient level on coral growth processes are still poorly understood.

4.4. Nitrogen Isotope Ratios ($\delta^{15}\text{N}$)

In general, $\delta^{15}\text{N}$ values in this study agree with other environmental variables as described earlier. Allison et al., (1991) also noted increased $\delta^{15}\text{N}$ values in area of elevated nutrient concentration. The average $\delta^{15}\text{N}$ value from Kayangan as an 'affected' site in this study is much higher compared to $\delta^{15}\text{N}$ value of coral sample of *P. lobata* (± 4.21 ‰) from affected site in Grave, Zanzibar and that value (± 7.2 ‰) from affected site in Male, Maldives (see Risk et. al, 1993).

The difference in nitrogen stable isotope values of coral tissue found among study sites indicates different isotopic composition of their diets as previously suggested by Wada and Hattori (1976), and Deniro and Epstein (1981). There is about a 3 ‰ enrichment in $\delta^{15}\text{N}$ values at each successively higher trophic level Wada and Hattori (1976). Given the result that the higher $\delta^{15}\text{N}$ value was found in Kayangan coral tissue, it implies that its nitrogen sources has a higher $\delta^{15}\text{N}$ ratios. Since this site is very close to the city, then human waste and sewage possibly contributed to these higher $\delta^{15}\text{N}$ values.

CHAPTER V

CONCLUSIONS AND RECOMMENDATIONS

5.1. Conclusions

- The low coral cover average at station Kayangan, is possibly attributed to the high sedimentation and eutrophication (sewage) from the mainland that decrease light availability and restrict coral distribution to the shallower area as well as decrease coral recruitment. Human interference (fish blasting, coral collection, anchoring, and other activities) may have affected Samalona and Barang Lompo more. Less 'stress' factors at station Kapoposan result in a high coral cover and number of species.
- A high number of species at 3m depth at Kayangan reef indicate a rather puzzling phenomenon perhaps produced by lower intraspecific competition among hermatyphic corals and adaptation of the coral survivors.
- Coral growth rates tended to be higher at more eutrophic reefs, but slower at a certain maximum critical nutrient value. However, the processes that govern the growth of coral are still poorly understood
- The high $\delta^{15}\text{N}$ values at Kayangan reef support the idea that this site was affected by human waste and sewage.

5.2. Recommendations

- More integrated long-term studies are needed to reveal some uncertainties in coral reef study at the area.

- Good organized coral reef management is desperately needed to protect the area from being deteriorated both by natural and human-induced 'stresses'. The community, especially local people, to be given information in order to help them to behave more friendly and environmentally sound to the coral reef as well as coastal areas in general.

- Serious actions and law enforcement absolutely need to be exercised to ban illegal and environmentally devastating fishing methods.

- More communication with respect to coral reef issues (in press, seminars or audio visual, etc.) are at the same needed.

REFERENCES CITED

- Aller, R. C., and Dodge, R. E., 1974. Animal-Sediment Relations in a Tropical Lagoon Discovery Bay Jamaica. *Journal of Marine Research*, **32** : 209 - 332.
- Atkinson, M. J., Carlson, B., and G. L. Crow, 1995. Coral Growth in high-nutrient, low-pH seawater: a case study of corals cultured at the Waikiki Aquarium, Honolulu, Hawaii. *Coral Reefs*: **14 (4)** : 215 - 223.
- Bak, R. P. M., 1978. Lethal and sublethal effects of dredging on reef corals. *Mar. Pollut. Bull.* **9** : 14 - 16.
- Barbour, M. G., Burk, J. H., and W. D. Pitts, 1987. *Terrestrial Plant Ecology*. Second Edition. The Benjamin/Cummings Publishing Company, Inc.
- Barnes D. J., and Lough, J. M., 1993. On the Nature and Causes of Density Banding in a Massive Coral Skeletons. *Jour. Exp. Mar. Biol. Ecol.*, **267** : 91 - 108.
- Bell, P.R.F., 1991. Status of Eutrophication in the Great Barrier Reef Lagoon. *Marine Pollution Bulletin*. **23** : 89 - 93.
- Boto, K., and Isdale, P., 1985. Fluorescent Bands in Massive Corals Result from Territorial Fulvic Acid Inputs to Nearshore Zone. *Nature*, **315** : 396 - 397.
- Buddemeier, R. W., and Kinzie III, R. A., 1976. Coral Growth. *Oceanogr. Mar. Biol. Ann. Rev.*, **14** : 183 - 225.
- Buddemeier, R. W., Maragos, J. E., and D. K. Knutson, 1974. Radiographic studies of reef coral exoskeletons : Rates and Patterns of coral growth. *J. Exp. Mar. Biol. and Ecol.* **14** : 179 - 200.
- Carter, J., 1994. *Training Module: Coral Reef Management Issues*. Marine Science Education Project. Indonesia.
- Chadwick, N. E., 1988. Competition and locomotion in a free-living fungid coral. *J. Exp. Mar. Biol. Ecol.*, **123** : 189 - 200.
- Changsang, H., 1984. Coral Reef Survey Methods in the Andaman Sea. Comparison Coral Reef Survey Methods. *Unesco Report in Marine Science*, **21** : 27 - 35.
- Chappel, J., 1980. Coral morphology, diversity and reef growth. *Nature*, London. **286** : 249 - 252

- Chou, L. M., 1984. A Review of Coral Reef Survey and Management Methods in Singapore. Comparison Coral Reef Survey Methods. *Unesco Report in Marine Science*. 21 : 36 - 46.
- Chugaynova, V. A., Nesvetova, G. I., Konnov, V. A., and Maksimova, M. P., 1993. Organic Nitrogen and Phosphorus Forms in White Sea Bays. *Oceanology*, 33 : 167 - 174.
- Constantz, B. R., 1986. Coral Skeleton Construction: A Physiochemically Dominated Process. *Palaios* 1 : 152 - 157.
- Cortes, N. J. and Risk, M. J., 1985. A reef under siltation stress: Cahuita, Costa Rica. *Bull. Mar. Sci.* 36 (2) : 339 - 356.
- Cortes, N. J., 1981. *The Coral Reef at Cahuita, Costa Rica, a Reef Under Stress*. M.Sc Thesis, McMaster University. Canada.
- Craik, W., Kenchington, R., and Kelleher, G., 1990. Coral Reef Management. *Ecosystem of the world 25*. Edited by Z. Dubinsky. Elsevier. 453 - 468.
- Crossland, C. J., 1993. Dissolved Nutrients in Coral Reef Waters. *Perspective on Coral Reefs*. Edited by D.J. Barnes. The Australian Institute of Marine Science. 56 - 68.
- Dallmeyer, D. G., Porter, J. W., and G. J. Smith, 1982. Effects of particulate peat on the behavior and physiology of the Jamaican reef-building coral *Montastrea annularis*. *Mar. Biol.* 68 : 229 - 233.
- Davies, P. J., 1983. Reef Growth. *Perspective on Coral Reefs*. Edited by D.J. Barnes. The Australian Institute of Marine Science. 60 - 106.
- de Vantier, L. M., 1986. Studies in the assessment of coral reef ecosystems. In: Brown, B. E. (Editor) "Human Induced Damage To Coral Reefs". *Unesco Reports in Marine Science*, 40 : 99 - 111.
- DeNiro, M.J. and Epstein, S., 1981. Influence of diet on the distribution of nitrogen isotopes in animals. *Geochimica Cosmochimica Acta*. 45: 341 - 351
- D'Elia, C. F., and Wiebe, W. J., 1990. Biochemical Nutrient Cycles in Coral-Reef Ecosystem. *Ecosystem of the world 25*. Edited by Z. Dubinsky. Elsevier. 49 - 74.

- Dodge R. E., Aller, R. C., and Thomson, J., 1974. Coral Growth Related to Resuspension of Bottom Sediments. *Nature*, **247** : 573-577.
- Dodge, R. E., and Vaisnys, J. R., 1977. Coral Population and Growth Patterns: Responses to Sedimentation and Turbidity Associated with Dredging. *J. mar. Res.* **35** : 715 - 730.
- Dunn, J. J. 1995. *Application of Nitrogen isotopes and other tracers of anthropogenic input to modern reefs*. M.Sc. Thesis, McMaster Univ. Canada
- Dustan, P., 1993. Developing Methods for Assessing Coral Reef. Global Aspect of Coral Reefs. *Health Hazard and History*. University of Miami: M8 - M14.
- Edinger, E. N., 1991. *Mass Extinction of Caribbean Corals at the Oligocene-Miocene Boundary: Paleoecology, Paleoceanography, Paleobiogeography*. M.Sc., Thesis, McMaster University, Hamilton, Canada.
- Edinger, E. N., and Risk, M. J., 1994. Oligocene-Miocene Extinction and geographic Restriction of Caribbean Corals: Roles of Turbidity, Temperature, and Nutrients. *Palaios*, **9** : 576 - 598.
- English, S., Wilkinson, C., and Bakert, V., 1994. *Survey Manual for Tropical Marine Resources*. Australian Institute of Marine Science. 368 pp.
- Erfteemeijer, P. L. A., 1994. Differences in Nutrient Concentration and Resources Between Seagrass Communities on Carbonate and Terrigenous Sediment in South Sulawesi, Indonesia. *Bull. Mar. Sci.*, **54** (2) : 403 - 419.
- Glynn, P. W., and Stewart, R. H., 1973. Distribution of Coral Reefs in the Pearl Islands (Gulf of Panama) in Relation to Thermal Conditions. *Limnol. Oceanogr.* **18** (3) : 367 - 379.
- Glynn, P.W., and G. M. Wellington, 1983. *Corals and coral reef of the Galapagos Islands*. University of California Press, Barkeley, 297 pp.
- Goreau, T. F., 1959. The Physiology of Skeleton Formation in Corals. A Method for Measuring the Rate of Calcium Deposition by Corals Under Different Condition. *Biol. Bull.*, **116** : 59 - 75
- Goreau, T., 1961. Problems of Growth and Calcium Deposition in Reef Corals. *Endeavour* : 32 - 39.

- Grigg, R. W., and Dollar, S. J., 1990. Natural and Anthropogenic Disturbance on Coral Reefs. *Ecosystem. Ecosystem of the world* 25. Edited by Z. Dubinsky. Elsevier. 439 - 452..
- Hallock, P., and Schlaager, W., 1986. Nutrient Excess and the Demise of Coral Reefs and Carbonate Platforms. *Palaios*, 1 : 389 - 398.
- Harger, J. R. E., (1984). Rapid Survey Techniques to Determine Distribution and Structure of Coral Communities. Comparison Coral Reef Survey Methods. *Unesco Report in Marine Science*. 21 : 83 - 91.
- Hatcher, B. G., Johannes, R. E., and Robertson, A. I., 1989. Review of Research Relevant to the Conservation of Shallow Tropical Marine Ecosystems. *Oceanor. Mar. Biol. Annu. Rev.*, 27 : 337 - 414.
- Hidaka, M., and K. Yamazato, 1984. Interspecific interactions in a scleractinian corals, *Galaxa fascicularis*: Induced formation of sweeper tentacles. *Coral Reefs* 3 : 77 - 85.
- Highsmith, R. C., 1979. Coral Growth Rates and Environmental Control of Density Banding. *J. Exp. Mar. Biol. Ecol.*, 37 : 105 - 125.
- Hopley, D., 1982. *The geomorphology of the Great Barrier Reef*. John Wiley and Sons.
- Isdale, P., 1984. Fluorescent Bands in Massive Corals Record Centuries of Coastal Rainfall. *Nature*, 310 : 578 - 579.
- Kinsey, D. W., and Davies, P. J., 1979. Effects of Elevated Nitrogen and Phosphorous on Coral Reef Growth. *Limnol. Oceano.* 24(5) : 935 - 940.
- Klerk, L. G. de, 1983. *Zeespiegels, riffen en kustvlakten in Zuidwest Sulawesi, Indonesia; een morphogenetisch-bodemkundige studie*. Thesis Univ. of Utrecht, the Netherlands: 1 - 172.
- Land, J. V. D., 1989. *Introduction of Netherlands Journal of Sea Research. Proceedings of Snellius-II Symposium*. 23 (2) : 83 - 84
- Lang, J. C., Maguire, B., King, A. J., and Dustan, P., 1993. Non-Invasive Research and Monitoring in Coral Reefs. *Global Aspect of Coral Reefs. Health Hazard and History*. University of Miami: M15 - M21.
- Lowenstam, H. A., 1981. Minerals formed by organisms: *Science*, 211 : 1126 - 1131.

- Loya, Y., 1972. Community structure and species diversity of hermatypic corals at Eliat, Red Sea. *Mar. Biol.* **13** (2) : 100 - 123
- Loya, Y., 1978. Plotless and transect methods. In: *Coral Reefs : Research Methods*, D.R. Stoddart and R.E. Johannes eds., Unesco, Paris : 197 - 217.
- Marsh, L. M., Bradbury, R. H., and R. E. Reichelt, 1984. Determination of the physical parameters of coral distributions using line transect data. *Coral Reefs* **2** : 175 - 180.
- McKenzie, J., Schaefer, L., and E. Farber, 1995. *The Student Edition of Minitab for Windows*. Addison-Wesley Publishing Company, Inc.
- Moll, H., 1983. *Zonation and Diversity of Scleractinia on Reefs off S. W. Sulawesi, Indonesia*. Offsetdrukkerij Kanters B.V., Alblaserdam.
- Montaggioni, L. F., Cuet, P., and Naim, O., 1993. Effect of Nutrient Excess on a Modern Fringing Reef (Reunion Island, Western Indian Ocean). Geological Implications. *Global Aspects of Coral Reefs. Health, Hazards, and History*. University of Miami, page : N27 - N33.
- Munro, J. L., and William, D. M., 1985. Assessment and Management of Coral Reef Fisheries : Biological, Environmental, and Socio-Economic Aspects. *Proceeding of the Fifth International Coral Reef Congress*, Tahiti Vol. **4** : 545 - 565.
- Newell, N. D., 1972. The evolution of the reef. *Sci. Am.* **226** : 54 - 65.
- Noor, A., 1993. *Kontribusi Hidrokarbon Petroleum Dalam Perusakan Karang Akibat Tekanan Eutrofikasi*. Dept. of Chemistry, Hasanuddin University, Indonesia. 21 pp.
- Norusis, M. J., 1994. *SPSS Advanced Statistics 6.1*. SPSS Inc. USA.
- Ongkosongo, O.S.R., and Sukarno, 1986. Background on the study sites in the Bay of Jakarta and Kepulauan Seribu. *Unesco Rep. Mar. Sci.* **40** : 56 - 79.
- Pedro, M. A., Herrera-Moreno, A., and N. Martinez-Estalella, 1993. Sessile communities as environmental Bio-Monitors in Cuban Coral Reefs. *Global Aspect of Coral Reefs. Health Hazard and History*. University of Miami: M1 - M7.

- Parsons, T. R., Maita, Y., and Lalli, C. M., 1984. *A Manual of Chemical and Biological Methods for Seawater analysis*. Pergamon Press. Oxford, England.
- Patzold, J., 1984. Growth Rhythms Recorded in Stable Isotopes and Density Bands in the Reef Coral *Porites lobata* (Cebu, Philippines). *Coral Reefs* 3 : 87 - 90.
- Risk, M. J., 1972. Fish diversity on a coral reef in the Virgin Islands. *Atoll Res. Bull.*, 153 : 1 - 6.
- Risk, M. J., Pagani, S. E., and R. J. Elias., 1987. Another internal clock: preliminary estimates of growth rates based on cycles of algal boring activity. *Palaios*, 2 : 323 - 331.
- Risk, M. J., Dunn J. J., Allison, W. R., and Horril, C., 1993. Reef Monitoring in Maldivies and Zanzibar: Low-Tech and High-Tech Science. *Global Aspect of Coral Reefs*. Health Hazard and History. University of Miami: M36 - M42.
- Risk, M. J., and Muller, H. R., 1983. Porewater in Coral Heads: Evidence for Nutrient Regeneration. *Limnol. Oceano.*, 28 (5) : 1004 - 1008.
- Risk, M. J., and Sammarco, P. W., 1991. Cross-shelf Trends in Skeletal Density of the Massive Coral *Porites lobata* from the Great Barrier Reef. *Mar. Ecol. Prog. Ser.* 69 : 195 - 200.
- Rogers, C. S., 1990. Responses of coral reefs and reef organisms to sedimentation. *Mar. Ecol. Prog. Ser.* 62: 185-202.
- Rogers, C. S., 1983. Sublethal and lethal effects of sediments applied to common Caribbean reef corals in the field. *Mar. Pollut. Bull.* 14: 378 - 382
- Rose, C. S., and Risk, M. J., 1985. Increase in *Cliona delitrix* Infestation of *Montastrea cavernosa* Heads on an Organically Polluted Portion of the Gran Cayman Fringing Reef. *Mar. Ecol.* 6 (4) : 345 - 363.
- Shepard, F. P., Marshall, N. F., and McLoughlin, P. A., 1975. Hermatypic Coral Growth Banding as Environmental Recorder. *Nature*, 258: 706-708.
- Smith, F. G. W., 1976. *Atlantic Reef Corals*. University of Miami Press. Coral Gables, Florida. 164 p.
- Smith, R. L., 1986. *Elements of Ecology*, Second Edition. Harper and Row, Publishers, New York.

- Smith, S. V., Kimerer, W.J., Laws, E.A., Brock, R.E. and T.W. Walsh, 1981. Kaneohe Bay Sewage Diversion Experiment: Perspective on Ecosystem Responses o Nutritional Perturbation. *Pacific Science*. **35(4)** : 279 - 395.
- Souce, R., 1994. *Excel Professional Technique*. Que Corporation. USA.
- Storm, C., 1989. Influence of River Systems ad Coastal Hydrodynamics on The Water Quality during one Monsoonal Period. Instittu voor Ruimtelijk Onderzoek, Netherlands.
- Telesnicki, G. J., and W. M. Goldberg, 1995. Effects of turbidity on the photosynthesis and respiration of two South Florida reef coral species. *Bull. Mar. Sci.*, **57(2)** : 527 - 539.
- Thomson, J. C., and B. E. Brown, 1986. The cnidom: an index of aggressive proficiency in scleratinian corals. *Coral Reefs* **5** : 93 - 101.
- Tomascik, T., and Sander, F., 1985. Effect of Eutrophication on Reef-Building Corals. I. Growth Rates of the Reef-Building Coral *Montastres annularis*. *Mar. Biol.*, **87** : 143 - 155.
- Tomascik, T., and Sander, F., 1987. Effect of Eutrophication on Reef-Building Corals. II. Structure of Scleractinian Coral Communities on Fringing Reefs, Barbados, West Indies. *Mar. Biol.*, **94** : 53 - 75.
- Tomascik, T., 1993. Coral Reef Ecosystems: Environmental Management Guidelines. *EMDI Environmental Report No. 35*.
- Tuti, H. M. I. Y., and Rahma, 1993. *Analisa Data. Kursus Pelatihan Metodologi Penelitian Penentuan Kondisi Terumbu Karang*. Pusat Penelitian dan Pengembangan Oseanologi Lembaga Ilmu-Pengetahuan Indonesia. Jakarta.
- Umbrove, J. H. F., 1947. Coral Reefs of the East Indies. *Bull. Geol. Soc. Am.*, **729** - 778.
- Veron , J. E. N., 1986. *Corals of Australia and The Indo-Pacific*. University of Hawaii Press. Honolulu. 644 pp.
- Wada, E. and A. Hattori, 1978. Nitrogen isotope effects in the assimilation of inorganic nitrogenous compounds by marine diatoms. *Geomicrobiology Journal*. **1** : 85 - 101.

- Willoughby, N. G., 1986. Man-made flotsam on the strand-lines of the Thousand Islands (Kepulauan Seribu) Jakarta, Java. *Unesco Reports in Marine Science*, **40**: 157 - 163.
- Wittenberg, M., and Hunte, W., 1992. Effect of Eutrophication and Sedimentation on Juvenile Corals. I. Abundance, Mortality and Community Structure. *Mar. Biol.*, **112** : 131 - 138.
- Wood, R., 1993. Nutrients, Predation and the History of Reef-Building. *Palaios*, **8** : 526 - 543.
- Wyrski, 1961. Physical oceanography of the South-East Asian Waters. *Naga Report 2*, pp. 1 - 195.
- Yonge, C. M., 1968. Living Coral. *Proceeding of Royal Society B* **169** : 329 - 344.
- Yonge, C. M., 1973. The nature of reef-building (Hermatypic) corals. *Bull. Mar. Sci.*, **23** : 1 - 15.
- Zar, J. H., 1974. *Biostatistical Analysis*. Prentice-Hall, Inc., New Jersey. 620 p.

APPENDICES

Appendix A. Surface current on Indonesian sea and it's surrounding.

A) in February and B) in August (Source: PPPO, Jakarta)

Remarks : - Current velocity (cm/s) ; 12 ←--- 6
25 ←— 12
38 ←← 18
50 ←← 24
75 ←← 36
100 ←←← 48

- Isobath = 200 m

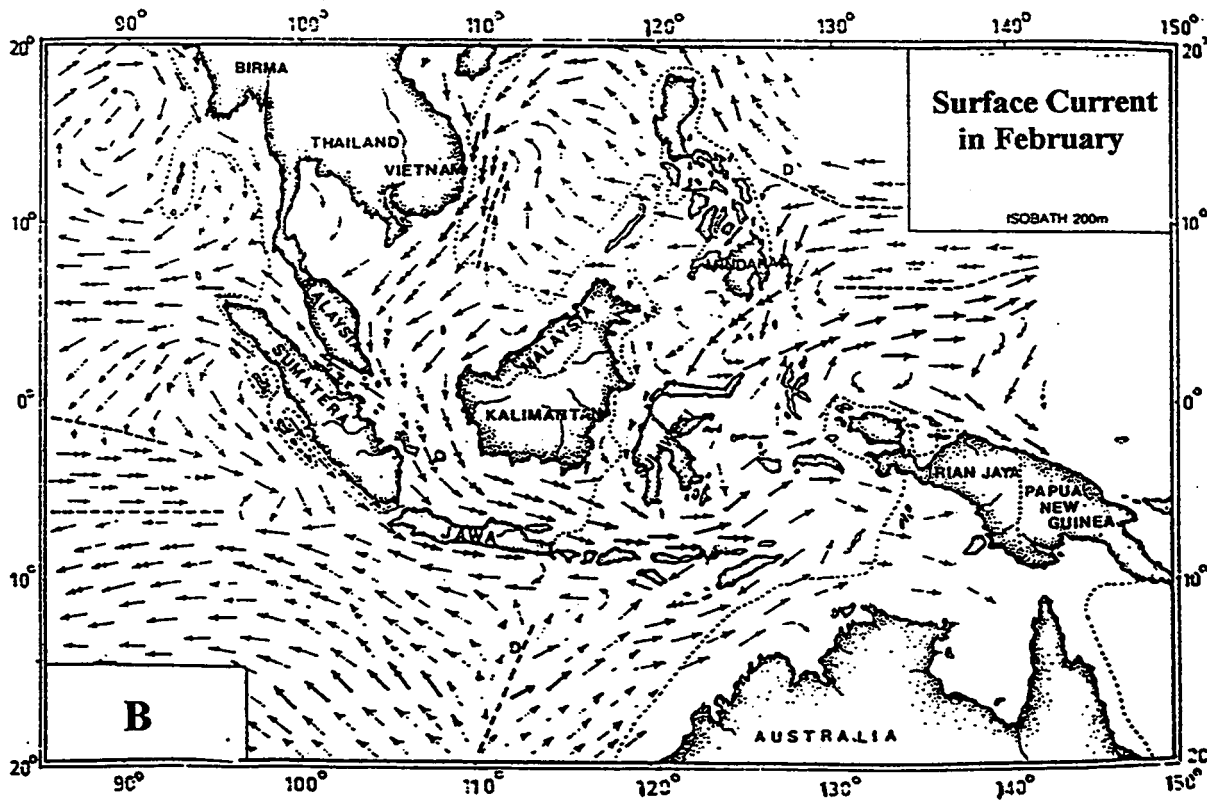
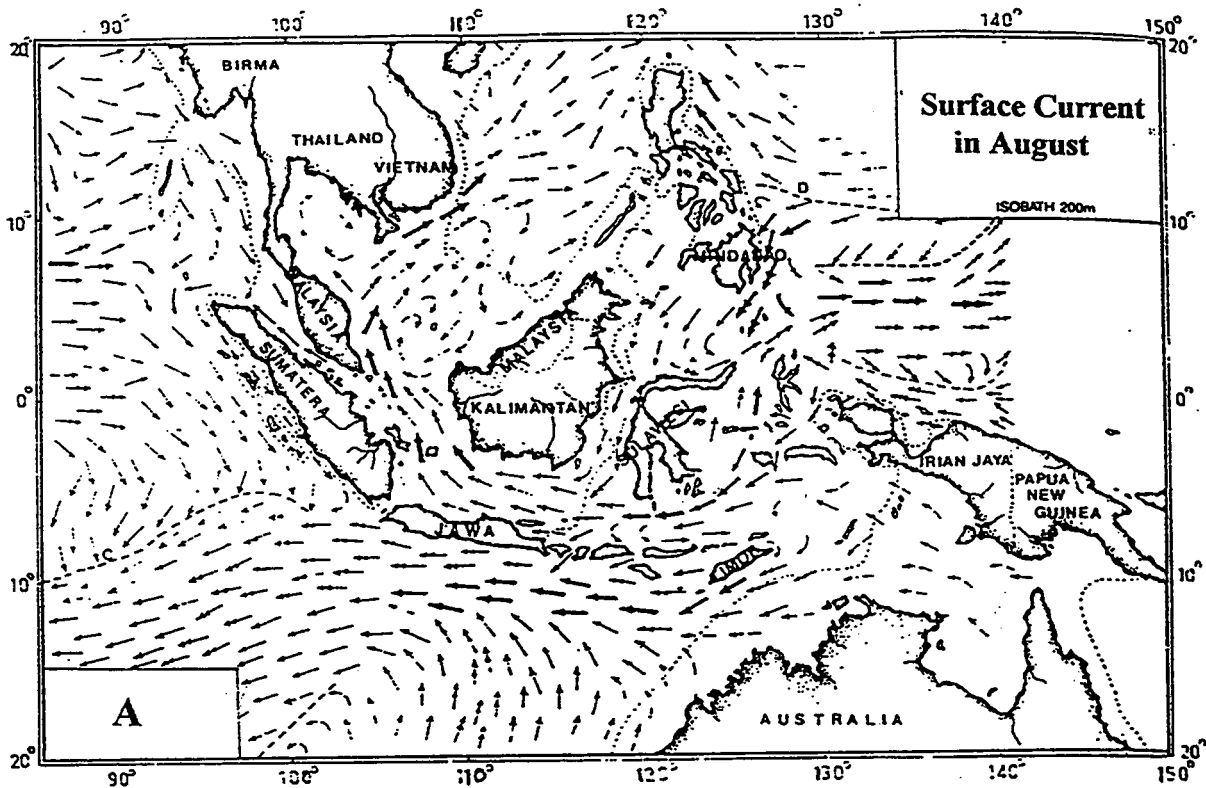

Appendix B. The average values of temperature (°C) at Ujung Pandang's vicinity every month from 1973 to 1995 (Source: Meteorology and Geophysics Board of Ujung Pandang, 1995)

Years	Jan	Peb	Mar	Apr	May	Jun	Jul	Aug	Sept	Okt	Nov	Des	Average
1973	25	26.5	26.7	26.4	25.9	26.3	25.5	26	26.2	27.1	25.6	25.4	26.1
1974	25.4	24.7	25.3	20.8	26.1	25.3	25.2	25.4	26.3	26.2	25.8	25.8	25.2
1975	25.2	25.4	25.2	25.8	25.8	25.4	24.9	25.6	25.9	26	25.9	25.2	25.5
1976	25.3	25.1	25.4	26.8	25.9	25.9	25.7	25.6	26.4	27.1	26.4	25.4	25.9
1977	25.2	25	26	26.4	26.4	25.3	23.7	25.3	26.5	27.5	27.5	26.3	25.9
1978	25.9	25.7	26.2	26.4	27.3	25.1	25.3	25.9	26	27.2	26.4	25.7	26.1
1979	25.6	25.6	25.8	26.5	26.7	26	25.1	25.4	27	27.5	28.2	26	26.3
1980	26.1	25.4	26	26.5	26.6	26.5	26.2	25.7	27	27.7	27.4	25.5	26.4
1981	25.6	25.5	26	26.4	26.4	25.9	25.6	25.4	27.1	27.9	26.2	25.4	26.1
1982	25.7	25.4	25.7	25.9	26.3	25.8	24.2	25.5	26.3	27.3	28.4	27.4	26.2
1983	26.5	26.7	27	26.7	26.4	26.3	25.5	26.2	27.2	27.5	26.4	26	26.5
1984	25.3	25.2	25.6	25.9	25.9	25.7	25.3	25.6	27.2	26.5	26.7	25.6	25.9
1985	25.7	26	26	26.3	26.5	25.9	25.4	25.6	26.7	27.4	26.9	26.1	26.2
1986	25.9	25.4	25.8	26.4	26.5	26.3	25.7	26.1	26.8	27.1	26.7	26.5	26.3
1987	25.4	25.9	26.3	26.8	26.7	26.6	26.4	26.6	27.2	28.6	28.1	26.1	26.7
1988	26.7	25.5	27	27.2	26.9	25.6	26	26.3	26.7	27.7	26.4	25.1	26.4
1989	25.7	25.3	25.9	26.5	26.5	25.9	25.6	25.8	27.2	26.8	27	29.3	26.5
1990	25.6	26.3	26.5	26.9	26.5	26.3	25.7	26	26.3	27.8	27.4	26.1	26.5
1991	25.7	25.8	26.8	26.6	27	26.3	25.6	26.2	26.6	27.2	27.7	26.6	26.5
1992	26	26.1	26.4	27	26.8	26.2	25.6	25.7	26.8	27.3	26.7	26.6	26.4
1993	26.3	25.8	25.7	26	26.7	25.9	25.7	25.9	26.8	27.7	27.6	26.1	26.4
1994	25.9	26.2	26	26.4	26.5	26	25.8	26	26.6	27.7	27.8	26.9	26.5
1995	26.1	25.8	26.1	26.3	26.8	26.6	25.9	26.2					26.2
Aver:	25.7	25.7	26.1	26.2	26.5	26.0	25.5	25.8	26.7	27.3	27.0	26.1	26.2

Appendix C. The average value of monthly total rain falls (mm) at Ujung Pandang's vicinity from 1972 to 1995 (Source: Meteorology and Geophysics Board of Ujung Pandang, 1995).

Years	Jan	Peb	Mar	Apr	May	Jun	Jul	Aug	Sept	Okt	Nov	Des	Total =
1972	872	527	326	107	57	-	-	9	-	-	2	142	2042
1973	277	120	230	187	174	59	43	59	132	62	676	464	2483
1974	590	745	576	34	158	33	83	-	161	241	266	587	3474
1975	351	278	530	338	136	68	108	63	58	277	364	389	2960
1976	437	453	458	10	56	28	41	-	-	134	295	409	2321
1977	947	1275	263	355	35	112	2	12	-	-	183	324	3508
1978	561	494	230	190	202	198	141	35	58	36	162	700	3007
1979	737	642	438	196	158	132	-	-	-	-	155	600	3058
1980	700	556	477	172	32	-	-	1	-	-	87	532	2557
1981	93	417	295	91	144	29	99	-	3	20	521	702	2414
1982	668	568	574	141	24	9	-	-	-	0	14	270	2268
1983	200	139	100	227	118	60	2	-	-	124	580	489	2039
1984	767	635	389	289	197	60	59	19	145	40	214	707	3521
1985	517	352	520	236	164	80	53	-	6	28	294	389	2639
1986	1224	422	452	251	38	47	56	-	4	88	264	235	3081
1987	849	450	283	72	95	-	-	-	-	24	41	1269	3083
1988	603	995	552	132	139	20	7	83	106	80	409	767	3893
1989	756	653	289	309	105	147	50	49	6	51	199	387	3001
1990	767	226	255	68	247	2	24	4	4	40	223	727	2587
1991	699	397	248	283	23	1	42	-	2	-	81	442	2218
1992	491	316	353	165	26	162	3	2	83	42	155	347	2145
1993	762	415	353	266	78	85	4	-	-	23	293	783	3062
1994	605	383	471	58	48	11	-	-	-	-	101	373	2050
1995	939	651	1037	422	299	162	13	-	-	13	NA		NA
Average	642	505	404	192	115	72	46	31	59	74	243	523	

Appendix D. The average of monthly values of wind velocities (km/h) at Ujung Pandang's vicinities from 1973 to 1995 (Source: Meteorology and Geophysics Board of Ujung Pandang, 1995).

year	Jan	Peb	Mar	Apr	May	Jun	Jul	Aug	Sept	Oct	Nov	Des	Aver:
1973	5.9	5.1	5.2	4.7	3.9	3.6	3.9	4.3	4.3	4.8	5.9	5.2	4.73
1974	6.2	5.8	5.1	-	3.9	-	3.7	5.2	4.8	4.5	5.0	4.0	4.82
1975	5.9	-	4.6	8.6	-	-	-	-	4.2	5.1	-	5.9	5.72
1976	6.5	6.5	5.9	5.0	4.5	4.5	4.9	6.0	6.4	6.3	5.5	5.1	5.59
1977	5.1	6.7	-	5.1	4.8	4.1	4.7	5.7	6.4	7.2	6.9	5.7	5.67
1978	5.8	5.1	4.9	4.9	4.1	4.3	4.8	4.6	4.7	5.3	5.3	5.3	4.93
1979	5.5	5.2	5.2	4.8	4.4	3.7	4.7	5.6	6.6	7	6.7	6.4	5.48
1980	6.6	5.9	5.2	4.8	4.4	5.3	4.6	6.2	6.9	6.9	6.3	5.8	5.74
1981	6.1	5.5	4.6	4.5	4	4.4	4.3	6.1	5.6	6	5.9	5.8	5.23
1982	5.2	5	5	4.4	4.2	5	5.4	6.1	6.2	6.5	6.9	6.7	5.55
1983	5	4.8	4.7	4.5	3.1	3.1	4	5.3	6.3	5.9	6.4	5.3	4.87
1984	5.1	5.2	4.5	3.7	3.2	3.2	3.8	4.5	4.6	4.9	5.4	5.5	4.47
1985	5.3	5	5.3	4.2	3.9	3.5	3.8	4.2	5.6	6.4	5.8	5.3	4.86
1986	6.6	5.1	4.3	4.3	4	4.2	4.8	6	6.2	5.5	5.2	5.4	5.13
1987	5.4	5.8	4.2	4.4	4.1	4.7	5.3	5.9	6.4	7.1	6.4	6	5.48
1988	5.3	5.2	5	3.6	3.2	2.7	3.1	4	4	4.9	5.1	5.4	4.29
1989	4.7	4.9	5.2	3.9	4.1	3.9	3.6	4.7	4.9	5	5.1	5.2	4.60
1990	5.2	4.8	5.3	4.7	3.9	4	4.2	5	6.3	6.2	5.6	5	5.02
1991	4.9	5.3	4.4	4.4	3.7	4.4	4.6	5.3	6	6.5	6.1	5.2	5.07
1992	4	4.5	4.3	4	4	3.5	4.1	5	4.5	5.1	5.5	5.3	4.48
1993	5.8	5.4	4.4	4.4	3.9	2.9	3.1	4.4	5.1	5.1	4.5	4.5	7.76
1994	4	4	3.6	2.9	2.9	3.9	3.9	4.7	5.1	5.7	4.9	5	4.22
1995	4.5	3.8	3.9	3.5	2.8	2.7	3.9						3.59
Aver:	5.42	5.21	4.76	6.31	3.86	3.89	4.24	5.18	5.50	5.81	5.73	5.41	5.10

Note : Empty data mean unrecorded value (lost)

Appendix E. Lifeform categories and codes.

CATEGORIES	CODE	NOTES / REMARKS
Hard Coral:		
Dead Coral	DC	recently dead, white dirty white
Dead Coral with Algae	DCA	this coral is standing, but no longer white
Acropora		
Branching	ACB	at least 2° branching, e.g. <i>Acropora palmata</i> , <i>A. formosa</i>
Encrusting	ACE	usually the base-plate of immature Acropora forms, e.g. <i>A. palifera</i> and <i>A. cuneata</i>
Submassive	ACS	robust with knob or wedge-like form e.g. <i>A. palifera</i>
Digitate	ACD	no 2° branching, typically includes <i>A. humilis</i> , <i>A. digitifera</i> and <i>A. gemmifera</i>
Tabulate	ACT	horizontal flattened plates e.g. <i>A. hyacinthus</i>
Non-Acropora Branching	CB	at least 2° branching e.g. <i>Seriatopora hystrix</i>
Encrusting	CE	major portion attached to substratum as a laminar plate e.g. <i>Porites vaughani</i> , <i>Montipora undata</i> .
Foliose	CF	coral attached at one or more points, leaf-like appearance e.g. <i>Merulina ampliata</i> , <i>Montipora aequituberculata</i> .
Massive	CM	Solid boulder or mounded e.g. <i>Platygyra daedalea</i> .
Submassive	CS	tends to form small columns, knobs, or wedges e.g. <i>Porites lichen</i> , <i>Psammocora digitata</i> .
Mushroom	CMR	solitary, free-living corals of the <i>Fungia</i>
<i>Millepora</i>	CME	fire coral
<i>Heliopora</i>	CHL	blue coral

Appendix E (continued)

Other Fauna:

Soft Coral		SC	soft bodied corals
Sponges		SP	
Zoanthids		ZO	examples are <i>Palythoa</i> , <i>Protopalythoahoa</i> .
Others		OT	Ascidians, anemones, gorgonians, giant clams, etc.
Algae	Algal Assemblage	AA	consists of more than one species
	Coralline Algae	CA	
	<i>Halimeda</i>	HA	
	Macroalgae	MA	weedy/fleshy browns, reds, etc.
	Turf Algae	TA	lush filamentous algae, often found inside damselfish territories.
Abiotic	Sand	S	
	Rubble	R	unconsolidated coral fragments
	Silt	SI	
	Water	WA	fissures deeper than 50 cm
	Rock	RCK	
Other		DDD	missing data

Appendix F-1. Example of lifeform categories which group benthic communities through the use of morphological characteristics. Inset show primary and secondary branching (From English, *et al.*, 1994).

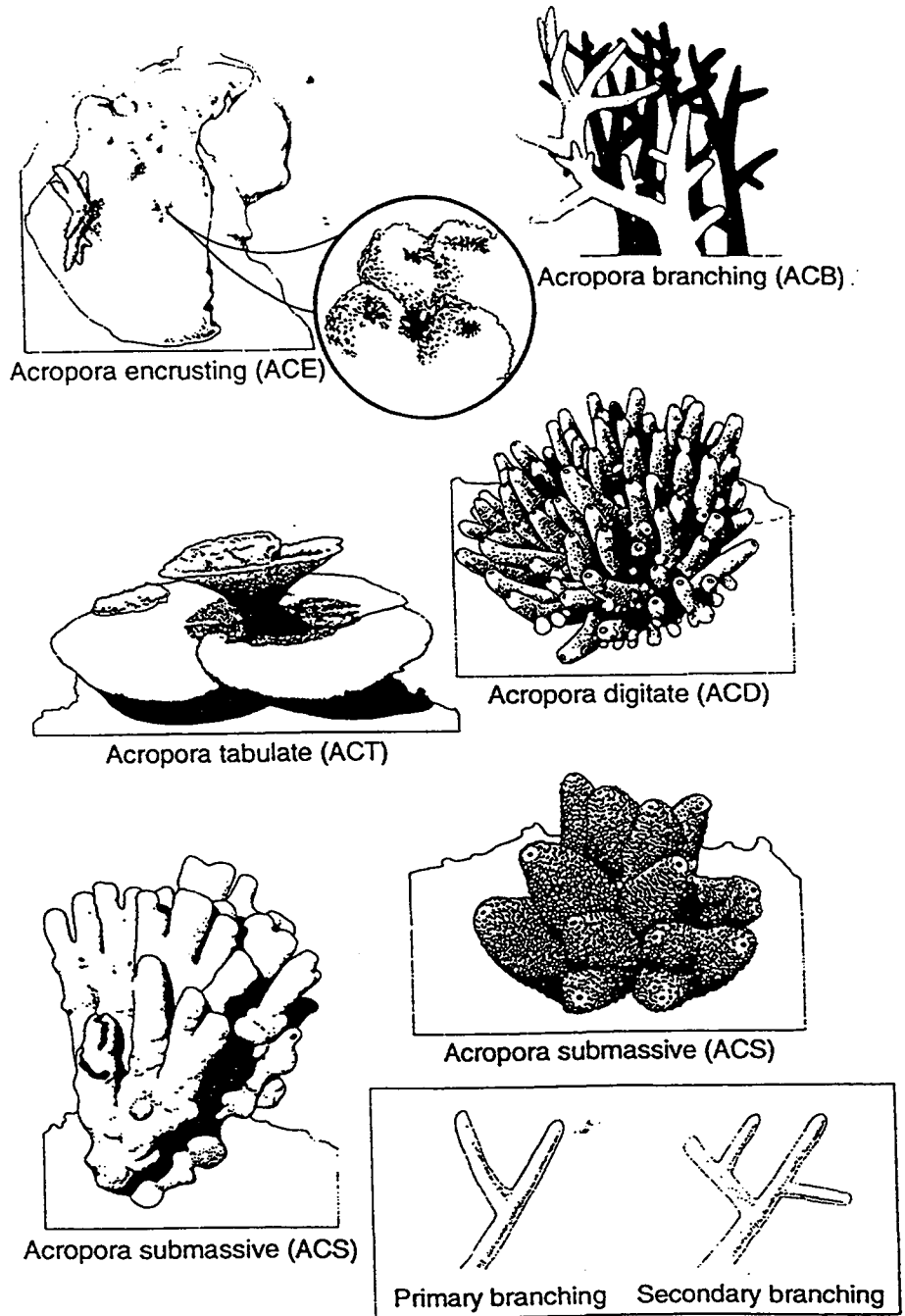

Appendix F-2. Example of lifeform categories which group benthic communities through the use of morphological characteristics (From English, *et al.*, 1994).



Coral foliose (CF)

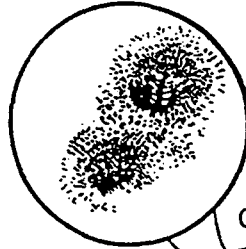

Coral encrusting (CE)

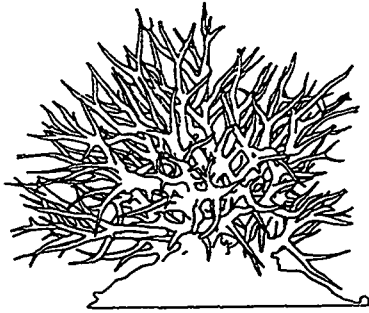

Coral branching (CB)

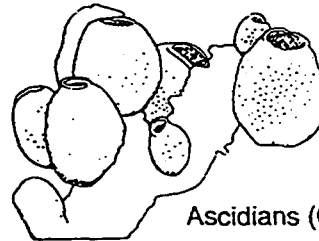

Ascidians (OT)

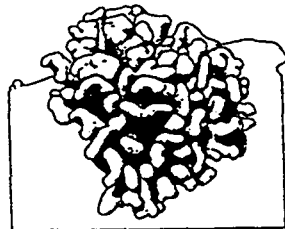

Coral submassive (CS)

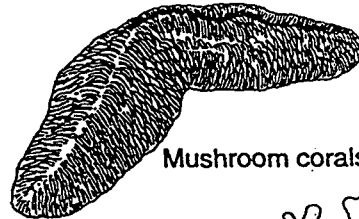

Mushroom corals (CMR)

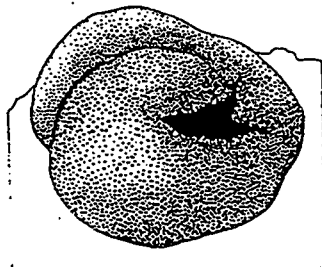

Coral massive (CM)



Millepora (CME)

Appendix F-3. Example of lifeform categories which group benthic communities through the use of morphological characteristics (From English, *et al.*, 1994).

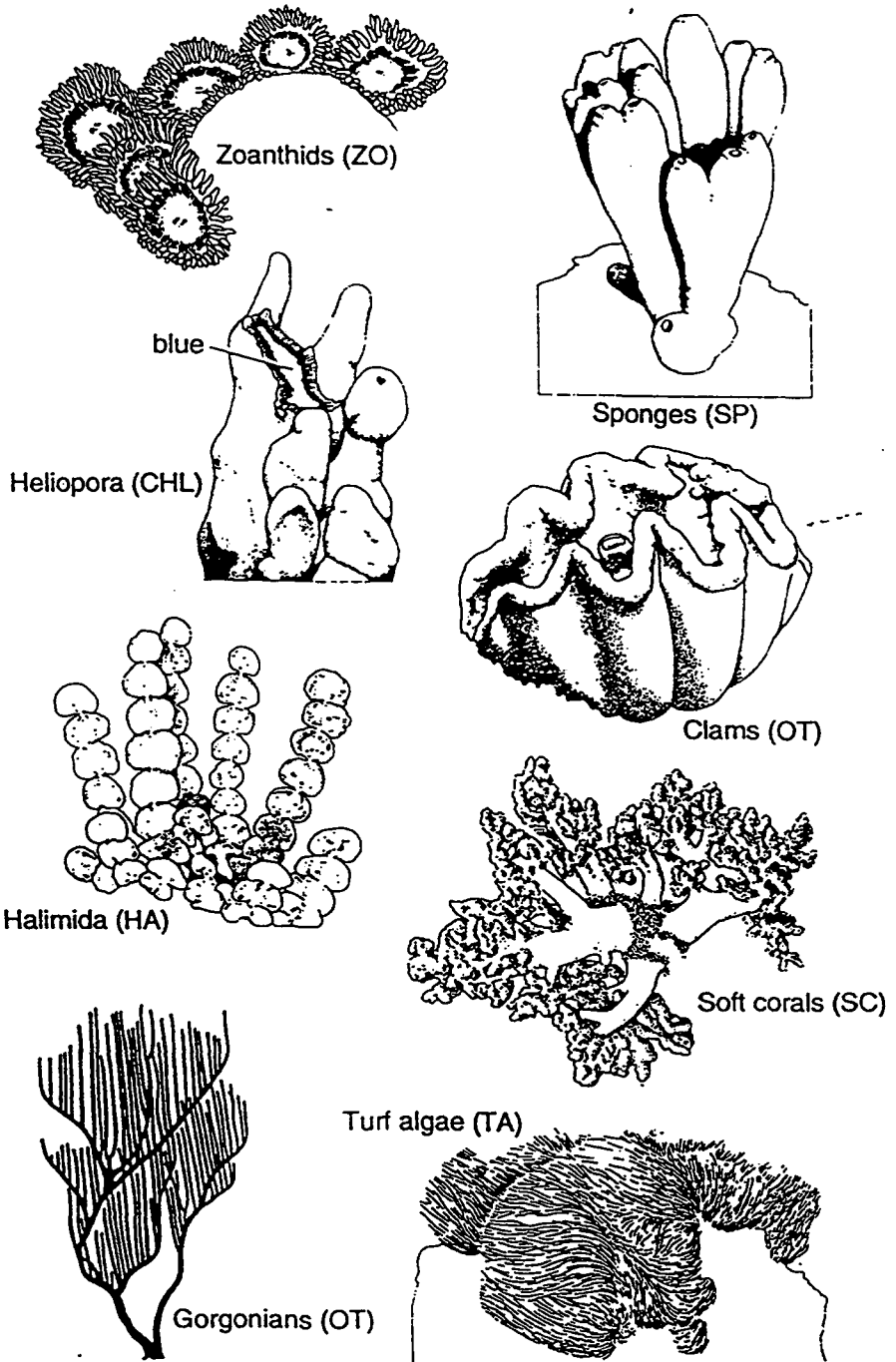

Appendix G.1. Pie charts of benthic communities of 3m and 10m Kayangan reefs

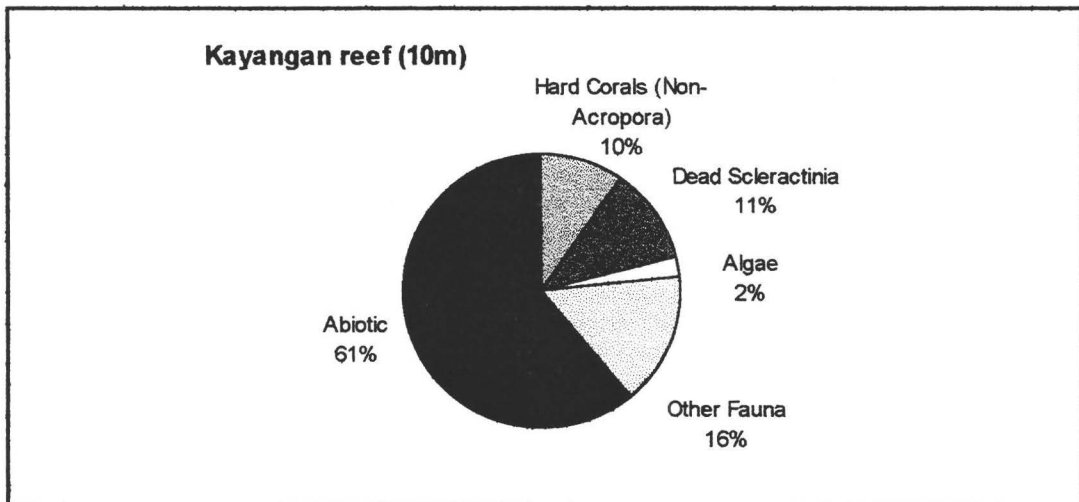
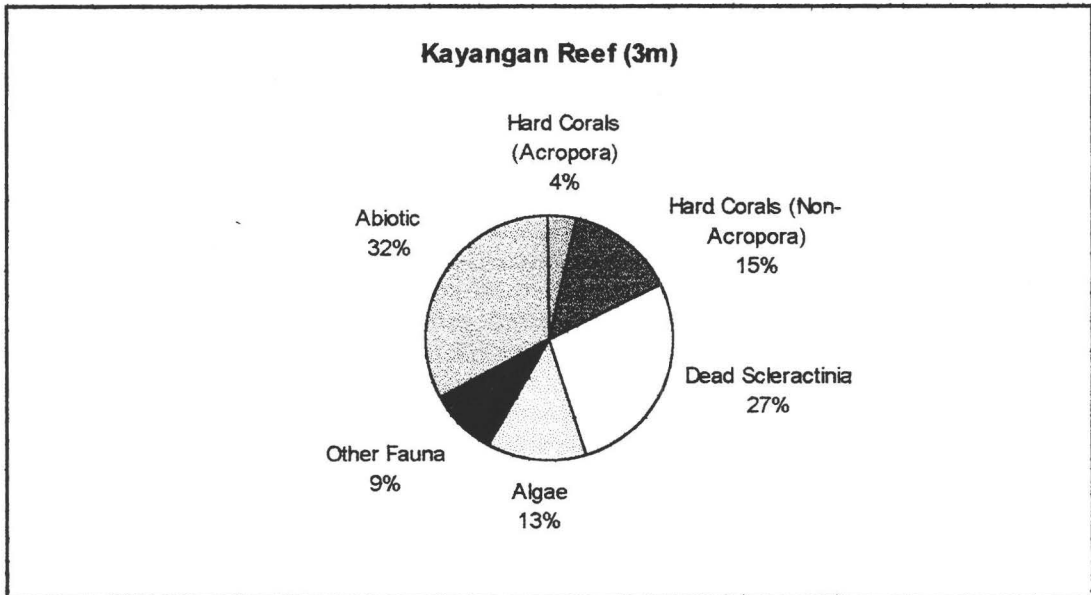

Appendix G.2. Pie charts of benthic communities of 3m and 10m Samalona reefs

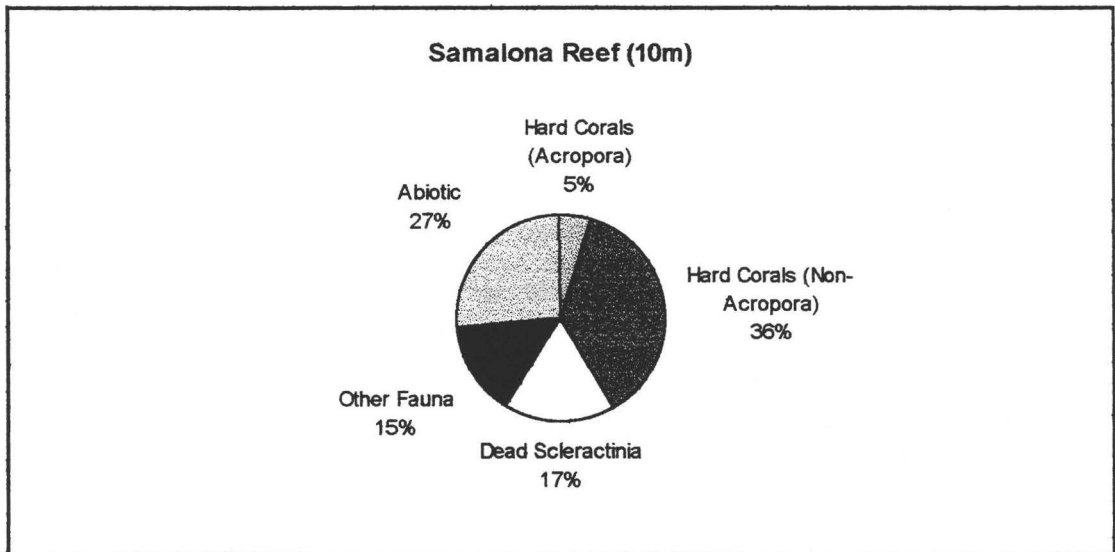
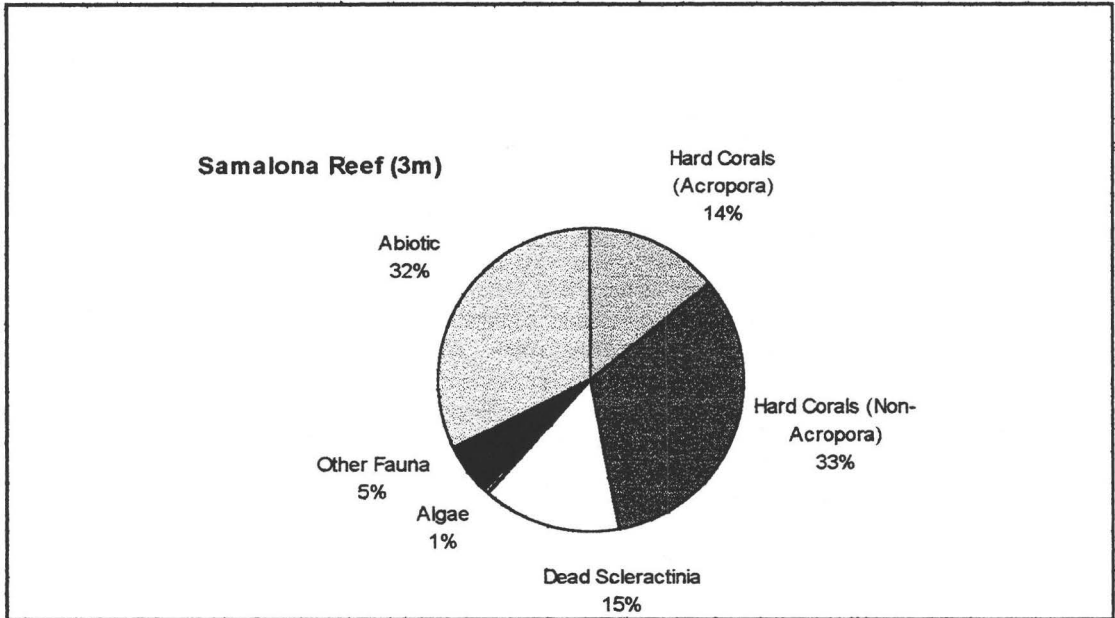

Appendix G.3. Pie charts of benthic communities of 3m and 10m B. Lompo reefs

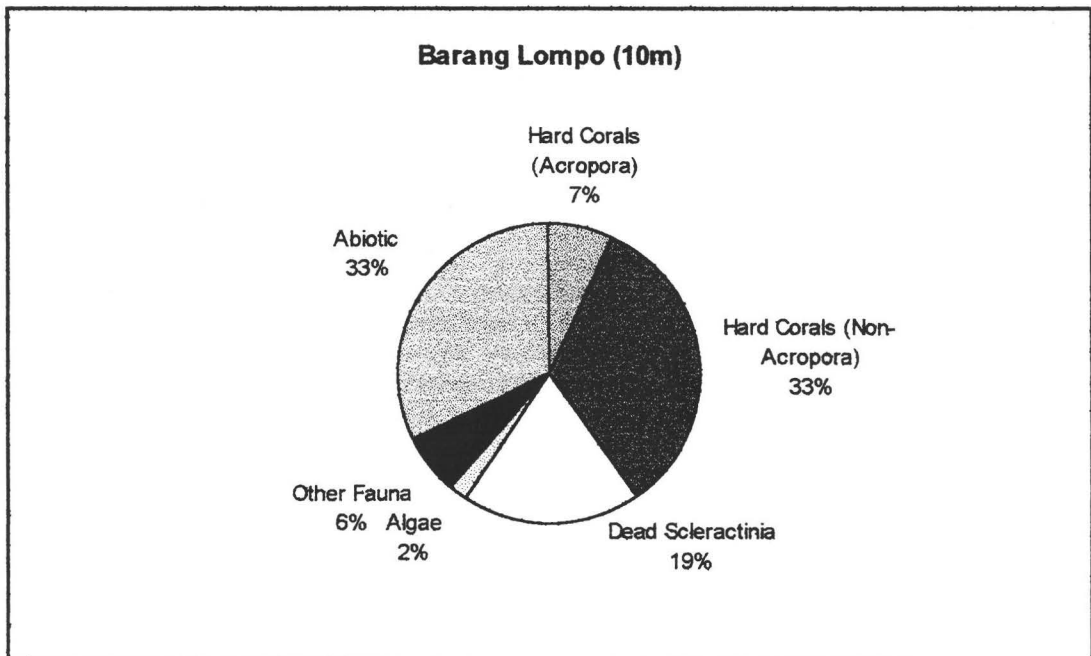
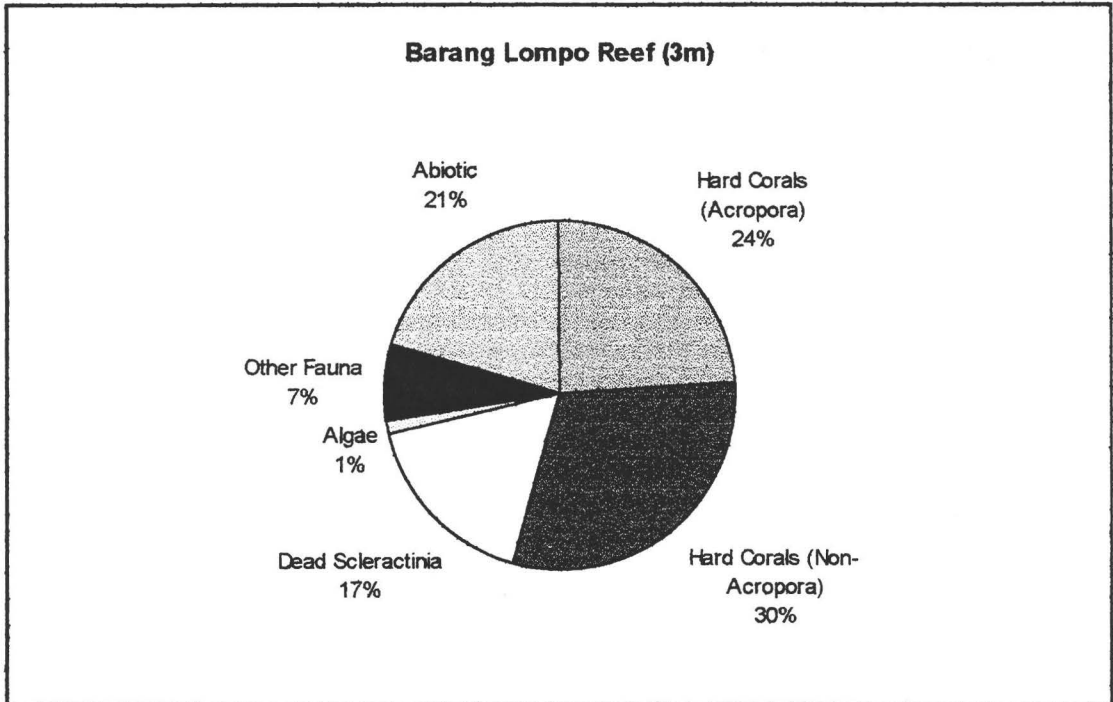

Appendix G.4. Pie charts of benthic communities of 3m and 10m Kapoposan reefs

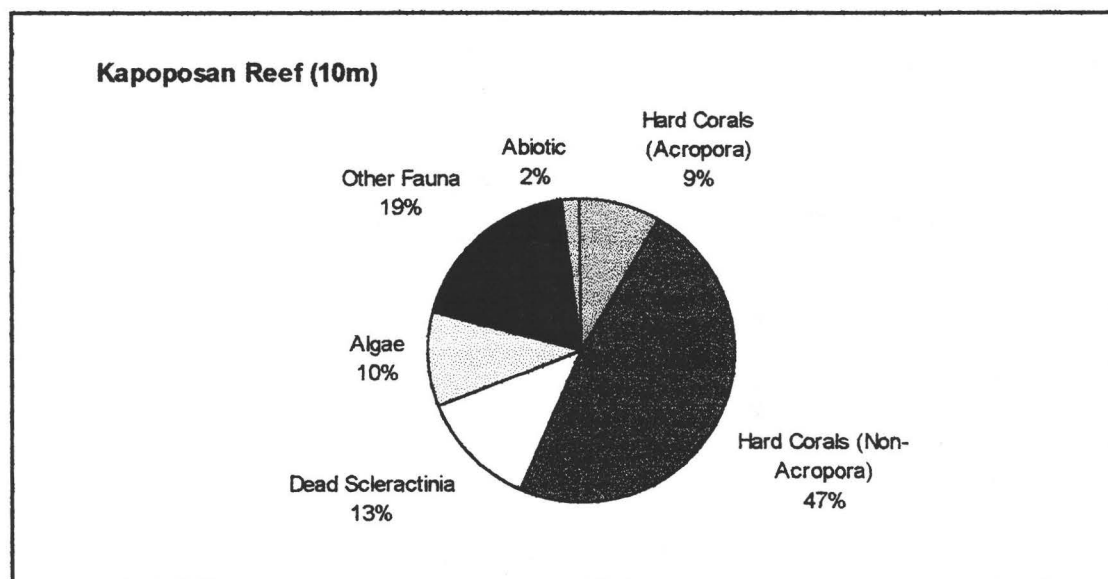
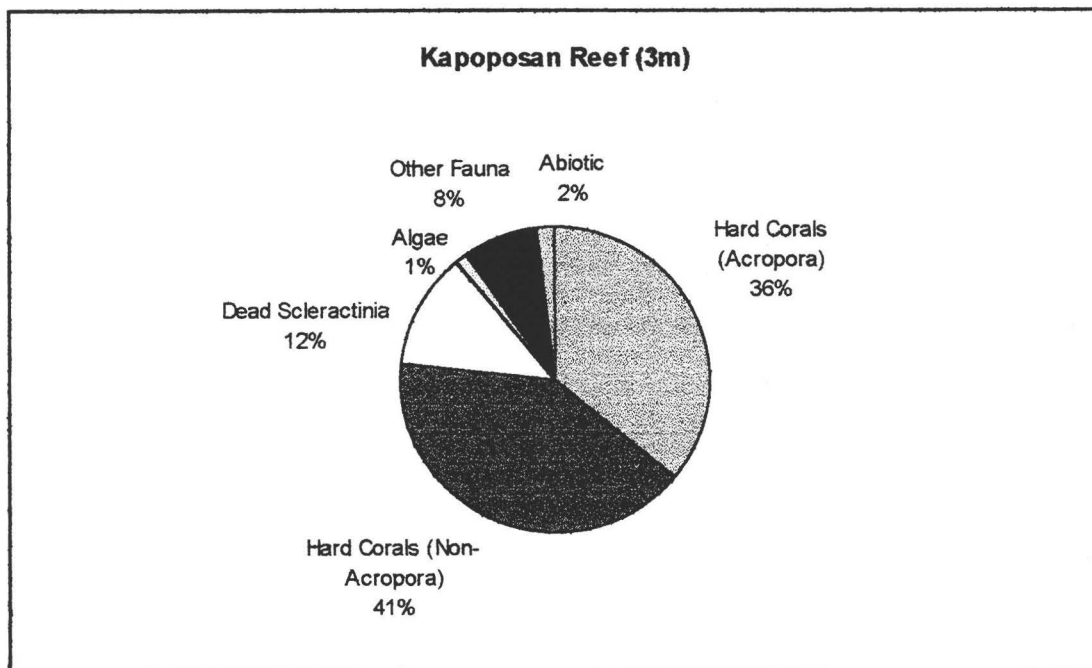

Appendix H. Individual coral growth-rates at all sites

<i>Coral Growth-rates at Kayangan</i>								
	<i>(mm)</i>			<i>Coral samples</i>				
<i>Years</i>	<i>1</i>	<i>2</i>	<i>3</i>	<i>4</i>	<i>5</i>	<i>6</i>	<i>7</i>	<i>Aver:</i>
1995	15	22	14	19	15	10	18	16.1
1994	13	19	14	16	11	11	19	14.7
1993	11	19	10	17	13	9	16	13.6
1992	14	16	11	15	13	9	15	13.3
1991	15	17	11	14	11	15	11	13.4
1990	16	22	10	16	11	17	13	15.0
1989	16	22	12	18		15		16.6
1988	17	15	11	18		11		14.4
1987	18	16	11					15.0
							<i>Aver:</i>	<u>14.7</u>

<i>Coral Growth-rates Samalona</i>							
	<i>(mm)</i>			<i>Coral samples</i>			
<i>Years</i>	<i>1</i>	<i>2</i>	<i>3</i>	<i>4</i>	<i>5</i>	<i>6</i>	<i>Aver:</i>
1995	12	13	13	15	11	14	13.0
1994	10	14	15	12	14	15	13.3
1993	13	16	16	12	12	17	14.3
1992	13	17	12	15	16	11	14.0
1991	13	12	14	14	15	15	13.8
1990	12	16			14	16	14.5
1989	13	17			12	12	13.5
1988	14	15			13	11	13.3
						<i>Aver:</i>	<u>13.7</u>

Appendix H (continued).

<i>Coral growth-rates at Barang</i>									
<i>Lompo (mm)</i>			<i>Coral samples</i>						
Years	1	2	3	4	5	6	7	8	Aver:
1995	16	21	12	18	15	14	19	14	16.1
1994	14	21	14	20	15	17	18	20	17.4
1993	14	20	16	20	12	14	15	18	16.1
1992	16	20	12	23	10	14	11	18	15.5
1991	19		10	19	10	16	12	18	14.9
1990	17		11	19	14	19	15	15	15.7
1989	17		15	19	15	14	20	19	17.0
1988				14	16	16	18		16.0
								<i>aver</i>	<u>16.1</u>

<i>Coral growth-rates at</i>							
<i>Kapoposan (mm)</i>			<i>Coral samples</i>				
Years	1	2	3	4	5	6	Aver:
1995	16	13	9	14	15	13	13.3
1994	15	11	9	13	14	14	12.7
1993	15	12	11	16	15	16	14.2
1992	15	13	11	19	11	17	14.3
1991	15	14	11	18	10	16	14.0
1990	12	16	12	15	11	14	13.3
1989	15	15	11		13		13.5
1988	15		10		10		11.7
						<i>aver:</i>	<u>13.4</u>

Appendix I.

List of coral species found in 10 m Kayangan reef

Cycloseris patelliformis
Fungia mohuccensis
F. paumotensis
Galaxea fascicularis
Polyphyllia talpina
Turbinaria peltata

List of coral species found in 3 m Kayangan reef

<i>Acropora cf. selago. grp.</i>	<i>Hydnophora pilosa</i>
<i>A. pulchra</i>	<i>H. excesa</i>
<i>Euphyllia glabrescens</i>	<i>Leptastrea transversa</i>
<i>Favia speciosa</i>	<i>L. transversa</i>
<i>F. mathaii</i>	<i>Lobophyllia hemprichii</i>
<i>F. pallida</i>	<i>Merulina ampliata</i>
<i>F. abdita</i>	<i>Montastrea curta</i>
<i>Favites halicora</i>	<i>Montipora cf. turgescens</i>
<i>F. flexuosa</i>	<i>M. digitata</i>
<i>F. pentagona</i>	<i>Pavona cactus</i>
<i>Fungia cf. repanda</i>	<i>P. decussata</i>
<i>F. cf. paumotensis</i>	<i>Platygyra sinensis</i>
<i>F. horrida</i>	<i>P. daedalea</i>
<i>Galaxea fascicularis</i>	<i>Pocillopora damicornis</i>
<i>G. astreata</i>	<i>Porites lobata</i>
<i>Goniastrea favulus</i>	<i>Seriatopora hystrix</i>
<i>G. edwardsi</i>	<i>Stylophora pistillata</i>
<i>G. aspera</i>	<i>Symphyllia recta</i>
<i>G. retiformis</i>	<i>S. radians</i>
<i>Herpolitha cf. weberi</i>	<i>Trachyphyllia sp</i>
<i>H. cf. limax</i>	<i>Turbinaria peltata</i>
	<i>T. reniformis</i>

Appendix I (continued). List of coral species in 10 m Samalona reef

<i>Acropora palifera</i>	<i>Lobophyllia corymbosa</i>
<i>A. humilis grp.</i>	<i>L. hemprichii</i>
<i>A. cf. selago grp.</i>	<i>Merulina ampliata</i>
<i>A. cf. formosa grp.</i>	<i>Montastrea curta</i>
<i>A. hyacinthus grp.</i>	<i>Montipora cf. millipora</i>
<i>A. sp grp. 4</i>	<i>M. cf. spumosa</i>
<i>Cyphastrea microphthalma</i>	<i>M. digitata</i>
<i>C. serailia</i>	<i>M. cf. peltiformis</i>
<i>Diploastrea heliopora</i>	<i>M. cf. caliculata</i>
<i>Echinopora lamellosa</i>	<i>M. cf. hispida</i>
<i>Euphyllia glabrescens</i>	<i>M. cf. foliosa</i>
<i>E. ancora</i>	<i>Mycedium elephantotus</i>
<i>Favia lizardensis</i>	<i>Pachyseris rugosa</i>
<i>F. pallida</i>	<i>P. speciosa</i>
<i>Favites abdita</i>	<i>Pavona decussata</i>
<i>Fungia fungites</i>	<i>P. cactus</i>
<i>F. valida</i>	<i>Pectinia lactuca</i>
<i>F. paumotensis</i>	<i>P. alcornis</i>
<i>Galaxea astreata</i>	<i>P. paeonia</i>
<i>G. fascicularis</i>	<i>Physogyra lichtensteini</i>
<i>Goniastrea pectinata</i>	<i>Platygyra daedalea</i>
<i>G. favulus</i>	<i>Plerogyra sinuosa</i>
<i>G. djiboutiensis</i>	<i>Porites cylindrica</i>
<i>Heliofungia actiniformis</i>	<i>P. lobata</i>
<i>Herpolitha limax</i>	<i>Seriatopora hystrix</i>
<i>Hydnophora pilosa</i>	<i>Stylophora pistillata</i>
	<i>Symphyllia recta</i>
	<i>S. radians</i>

List of coral species in 3m Samalona reef

<i>Acropora loripes grp.</i>	<i>Herpolitha limax</i>
<i>A. selago grp.</i>	<i>Montipora digitata</i>
<i>A. pulchra</i>	<i>M. hispida</i>
<i>A. cf. formosa grp.</i>	<i>M. caliculata</i>
<i>A. clathrata</i>	<i>M. crassituberculata</i>
<i>A. aspera grp.</i>	<i>Pavona cactus</i>
<i>A. robusta grp.</i>	<i>Pectinia lactuca</i>
<i>A. hyacinthus</i>	<i>P. paeonia</i>
<i>A. sp.</i>	<i>Plerogyra sinuosa</i>
<i>Echinopora horrida</i>	<i>Porites cylindrica</i>
<i>E. lamellosa</i>	<i>P. lobata</i>
<i>Euphyllia glabrescens</i>	<i>Seriatopora hystrix</i>
<i>Fungia fungites</i>	<i>S. caliendrum</i>
<i>F. valida</i>	<i>Stylophora pistillata</i>
<i>Galaxea fascicularis</i>	<i>Symphyllia recta</i>
<i>Goniastrea retiformis</i>	

Appendix I (continued). List of coral species found in 10 m Barang Lompo reef.

<i>Acropora pulchra</i>	<i>Leptastrea transversa</i>
<i>A. cf. pulchra</i>	<i>Lobophyllia hemprichii</i>
<i>A. palifera</i>	<i>L. corymbosa</i>
<i>A. cf. robusta</i> grp.	<i>Merulina ampliata</i>
<i>Cyphastrea serailia</i>	<i>Montastrea curta</i>
<i>C. japonica</i>	<i>Montipora digitata</i>
<i>Echinophyllia aspera</i>	<i>M. danae</i>
<i>Echinopora gemmacea</i>	<i>M. cf. caliculata</i>
<i>E. lamellosa</i>	<i>M. cf. foveolata</i>
<i>E. mammiiformis</i>	<i>M. cf. mollis</i>
<i>Favia speciosa</i>	<i>M. spumosa</i>
<i>F. mathaii</i>	<i>Mycedium elephantotus</i>
<i>F. stelligera</i>	<i>Oxypora lacera</i>
<i>F. lizardensis</i>	<i>Pachyseris speciosa</i>
<i>Favites pentagona</i>	<i>Pavona cf. varians</i>
<i>F. abdita</i>	<i>P. minuta</i>
<i>F. halicora</i>	<i>P. explanulata</i>
<i>Fungia fungites</i>	<i>Pectinia paeonia</i>
<i>F. simplex</i>	<i>P. alcicornis</i>
<i>Galaxea astreata</i>	<i>P. alcicornis</i>
<i>G. fascicularis</i>	<i>Platygyra daedalea</i>
<i>Gardineroseris planulata</i>	<i>P. sinuosa</i>
<i>Goniastrea pectinata</i>	<i>Porites cylindrica</i>
<i>G. edwardsi</i>	<i>P. lobata</i>
<i>G. favulus</i>	<i>Seriatopora hystrix</i>
<i>G. cf. minor</i>	<i>Symphyllia recta</i>
<i>Hydnophora pilosa</i>	<i>Turbinaria reniformis</i>
<i>H. excesa</i>	<i>T. frondens</i>
<i>H. rigida</i>	

List of coral species found in 3m Barang Lompo reef

<i>Acropora palifera</i>	<i>Goniopora tenuidens</i>
<i>A. cf. pulchra</i>	<i>G. djiboutiensis</i>
<i>A. cf. formosa</i>	<i>Leptoseris explanata</i>
<i>A. sp.</i>	<i>Montipora digitata</i>
<i>Coeloseris mayeri</i>	<i>M. caliculata</i>
<i>Cyphastrea microphthalma</i>	<i>M. foliosa</i>
<i>C. serailia</i>	<i>M. spumosa</i>
<i>Diploastrea heliopora</i>	<i>M. cf. grisea</i>
<i>Echinopora horrida</i>	<i>Pachyseris speciosa</i>
<i>E. gemmacea</i>	<i>P. clavus</i>
<i>E. lamellosa</i>	<i>P. cactus</i>
<i>Favia stelligera</i>	<i>Pectinia alcicornis</i>
<i>F. laxa</i>	<i>Platygyra daedalea</i>
<i>F. pallida</i>	<i>Porites lobata</i>
<i>Favites pentagona</i>	<i>P. cylindrica</i>
<i>Fungia cf. fungites</i>	<i>Seriatopora hystrix</i>
<i>Goniastrea pectinata</i>	<i>Symphyllia recta</i>

Appendix I (continued). List of coral species found in 10 m Kapoposan reef.

<i>Acanthastrea echinata</i>	<i>Merulina ampliata</i>
<i>Acropora cf. nasuta</i> grp.	<i>Montastrea valenciensesi</i>
<i>A. palifera</i>	<i>Montipora danae</i>
<i>A. spp.</i>	<i>M. foliosa</i>
<i>Alveopora verrilliana</i>	<i>M. aequituberculata</i>
<i>Coeloseris mayeri</i>	<i>M. cf. turgescens</i>
<i>Cyphastrea microphthalmia</i>	<i>M. hispida</i>
<i>Echinopora lamellosa</i>	<i>M. cf. millepora</i>
<i>E. gemmacea</i>	<i>M. caliculata</i>
<i>Favia mathaii</i>	<i>M. foveolata</i>
<i>F. stelligera</i>	<i>M. grisea</i>
<i>F. pallida</i>	<i>M. spumosa</i>
<i>Favites flexuosa</i>	<i>Oxypora glabra</i>
<i>F. abdita</i>	<i>Pachyseris speciosa</i>
<i>Fungia fungites</i>	<i>Pavona venosa</i>
<i>F. repanda</i>	<i>P. clavus</i>
<i>F. concinna</i>	<i>P. explanulata</i>
<i>Galaxea fascicularis</i>	<i>P. maldivensis</i>
<i>G. astreata</i>	<i>Platygyra pini</i>
<i>Goniastrea pectinata</i>	<i>P. daedalea</i>
<i>G. aspera</i>	<i>Pocillopora damicornis</i>
<i>G. favulus</i>	<i>P. verrucosa</i>
<i>G. edwardsi</i>	<i>Porites cylindrica</i>
<i>G. retiformis</i>	<i>P. lobata</i>
<i>Goniopora stutchburyi</i>	<i>P. cf. lichen</i>
<i>G. somaliensis</i>	<i>P. annae</i>
<i>Hydnophora pilosa</i>	<i>P. sp.</i>
<i>H. microconos</i>	<i>Sandalolitha robusta</i>
<i>H. rigida</i>	<i>Seriatopora hystrix</i>
<i>Leptoseris hawaiiensis</i>	<i>Stylophora pistillata</i>
<i>L. mycetoseroides</i>	<i>Symphyllia recta</i>

List of coral species found in 3 m Kapoposan reef

<i>Acropora cuneata</i>	<i>Herpolitha limax</i>
<i>A. formosa</i> grp.	<i>Leptastrea purpurea</i>
<i>A. humilis</i> grp.	<i>Merulina scabricula</i>
<i>A. longicyathus</i>	<i>Montipora spumosa</i>
<i>A. cf. nasuta</i> grp.	<i>M. foliosa</i>
<i>A. palifera</i>	<i>M. caliculata</i>
<i>A. cf. selago</i> grp.	<i>M. verrucosa</i>
<i>A. spp.</i>	<i>Mycedium elephantotus</i>
<i>Echinopora gemmacea</i>	<i>Pocillopora verrucosa</i>
<i>Favites abdita</i>	<i>Porites cylindrica</i>
<i>Fungia fungites</i>	<i>P. lobata</i>
<i>Galaxea fascicularis</i>	<i>Seriatopora caliendrum</i>
<i>Goniastrea aspera</i>	<i>S. hystrix</i>

Appendix J. Simple linear regression analysis of gradient of phosphate at four sites.

$$Y = 0.61518 - 0.084254X$$

$$R\text{-Squared} = 0.353$$

----- 95.0% Confidence Bands ----- 95.0% Prediction Bands

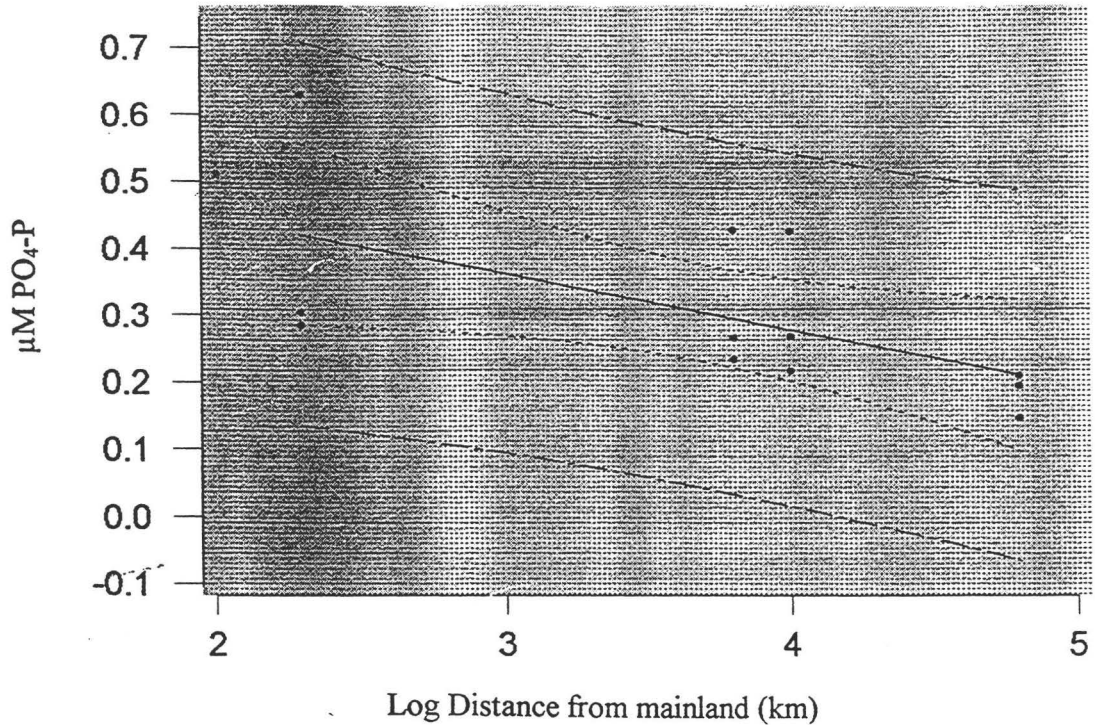

Predictor	Coef	Stdev	t-ratio	p
Constant	0.6152	0.1384	4.45	0.001
Distance	-0.08425	0.03610	-2.33	0.042

s = 0.1130

R-sq = 35.3%

R-sq(adj) = 28.8%

Analysis of Variance

SOURCE	DF	SS	MS	F	p
Regression	1	0.06959	0.06959	5.45	0.042
Error	10	0.12773	0.01277		
Total	11	0.19731			

Appendix K. Simple linear regression analysis of gradient of $\delta^{15}\text{N}$ at four sites.

$$Y = 11.3488 - 1.53350X$$

$$R\text{-Squared} = 0.660$$

----- 95.0% Confidence Bands ----- 95.0% Prediction Bands

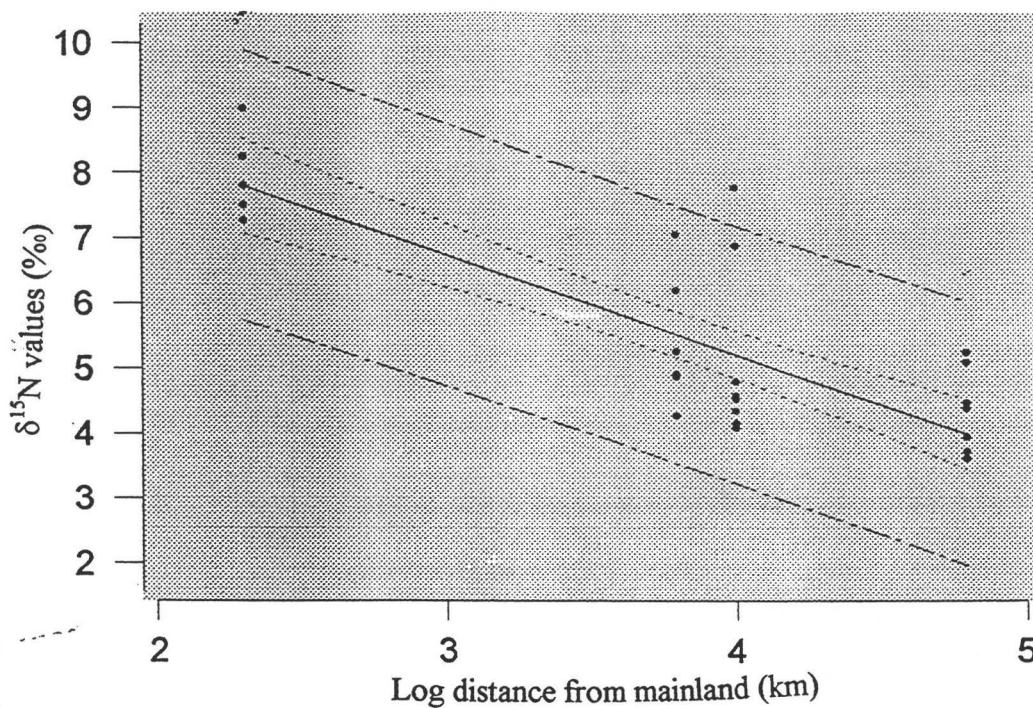

Predictor	Coef	Stdev	t-ratio	p
Constant	11.3488	0.8001	14.18	0.000
log dstc	-1.5335	0.2043	-7.51	0.000

s = 0.9547 R-sq = 66.0% R-sq(adj) = 64.9%

Analysis of Variance

SOURCE	DF	SS	MS	F	p
Regression	1	51.358	51.358	56.35	0.000
Error	29	26.430	0.911		
Total	30	77.789			

Appendix L.1. The value of Spearman correlation coefficient (r) within coral condition parameters; coral cover, coral growth rate and number of coral species (*italic*) and between those parameters and environmental variables ($n=4$).

	<i>Grw.rt</i>	<i>Spp. nbr</i>	NO ₃ -N	PO ₄ -P	NH ₄ -N	Chl. <i>a</i>	Clrty	Sal.
<i>Cvl.cvr</i>	-0.448 (<i>P=0.55</i>)	0.981 (<i>P=0.02</i>)	-0.948 (<i>P=0.05</i>)	-0.979 (<i>P=0.02</i>)	-0.952 (<i>P=0.04</i>)	-0.992 (<i>P=0.01</i>)	0.975 (<i>P=0.02</i>)	0.941 (<i>P=0.06</i>)
<i>Grw.rt</i>	-	-0.285 (<i>P=0.72</i>)	0.690 (<i>P=0.31</i>)	0.539 (<i>P=0.46</i>)	0.331 (<i>P=0.67</i>)	0.379 (<i>P=0.62</i>)	-0.544 (<i>P=0.45</i>)	-0.183 (<i>P=0.81</i>)
<i>Spp. nbr</i>	-	-	-0.868 (<i>P=0.13</i>)	-0.955 (<i>P=0.04</i>)	-0.928 (<i>P=0.07</i>)	-0.977 (<i>P=0.02</i>)	0.921 (<i>P=0.08</i>)	0.952 (<i>P=0.04</i>)

Appendix L.2. Summary of coral cover in average of 3m and 10m (%), number of species in total number of 3m and 10m, growth rates (mm yr⁻¹), NO₃-N (μ M), PO₄-P (μ M), NH₄-N (μ M), chlorophyll a ($g\ l^{-1}$), clarity (m-secchi), salinity (‰), SPM ($mg\ l^{-1}$), and resuspended sediment ($mg\ cm^{-2}\ d^{-1}$).

Station	Cr. Cvr	# Spp.	Grw. Rt.	NO ₃ -N	PO ₄ -P	NH ₄ -N	Chl. a	Clar.	Sal.	SPM	Rs. Se d
KY	14.0	45	14.9	0.85	0.41	0.98	1.52	5.07	31.4	19.3	2.84
SM	44.3	62	13.7	0.49	0.31	0.27	0.82	18.6	33.0	8.22	0.57
BL	47.2	71	15.9	0.63	0.3	0.27	0.75	15.93	33.4	8.62	0.65
KP	66.6	80	13.2	0.34	0.18	0.14	0.47	23.03	33.5	5.26	-